

**sēco**

**ACCESSORIES**  
**INVEST IN THE BEST**



### New Products



PAGE  
37

#### New Traverse Kits:

(2159-10 through -15)

Top-of-the-line traverse kits, with beam deviation accuracy of either <math><5</math> or <math><2</math>, copper or silver coated; along with high precision rotating tribach adapters and more.

#### Bipod to tripod leg – brought back by popular demand (5218-06)

Easily convert your existing prism/range pole bipod into a tripod for extra stability



PAGE  
26



PAGE  
15

#### TSC7/Ranger 7 ATV bracket

(5198-52)

Stable position holding on ATV, motorcycle or snowmobile



PAGE  
35

#### Mini 360 Prism Kit

(6406-02)

For Swiss-style instruments, Prism Accuracy <math><5</math> seconds



PAGE  
10

#### TSC7 /Ranger 7 Hook

(5196-22)

Hold your TSC7 securely to your instrument tripod



PAGE  
35

#### 360 Prism (6406-01)

Range up to 600M. Push-button quick release, designed for Swiss-style instruments and offsets

**Note on the Flags:** All products are available worldwide. The US flag means that the product is shipped from the US warehouse only. The EU flag means that it can also be shipped from our European warehouse.



Inventory subject to change without notice. Refer to SECO's website at [Surveying.com](http://Surveying.com) for the latest product information.





Land Surveying



GNSS



Construction Site Prep

Mining, Tunneling,  
Monitoring and Rail

Oil and Gas



Agriculture



GIS

## Section One

GNSS Accessories	5-13
Vehicle Accessories	14-15
Vials and Levels	16

## Section Two

Laser Scanner Accessories	17-19
Specialty Prism Poles	19-21
Prism Poles and Accessories	21-25
Prism Pole Bipods & Tripods	26-27

## Section Three

Prisms and Assemblies	29-32
Prism Systems, Sliding and Pin Pole Kits	33-34
Walleye and Mini Prisms	35-36
Prism Assemblies and Accessories, Adapters	36-37

## Section Four

Traverse Kits	37-38
GeoDesy Products	39-40
Tribrachs and Adapters	41
Tri-Max Tripods	42-43
Instrument Tripod and Accessories	44-47

## Section Five

Leveling Rods, Accessories and Brackets	48-51
Magnetic Locators	51
Measuring Tapes, Rulers, Cases and Gopher Pole	52-53
Stream Gauges and Supplies	54-55

## Section Six

Optical Instruments	56-57
Laser Detectors and Receivers	58-59

## Section Seven

Bullseye Construction Accessories	60
Monitoring Accessories, Wall/Column Clamps and Brackets	61-62
ANSI/ISEA Class Safety Utility Vests	63-66
Hydration Backpack, Bags and Cases	67-72
Magnetic Nails	73

## Section Eight

Flagging Dispenser and Marker	73
Miscellaneous Field Accessories	74
Rite in the Rain	75
Index by Part Number	76-78
Index by Description	79-82

## SECO MANUFACTURING

For decades, SECO Manufacturing Co., has stayed on the cutting edge of designing and manufacturing tools and accessories for surveying, construction, utilities and other industries that use GPS/GNSS technology.

SECO enjoys a global reputation for innovation and quality because we control each phase of product manufacture. We maintain an on-site manufacturing facility featuring state-of-the-art equipment to make certain that all products are made to meet SECO's strict quality standards. SECO quality is so well recognized worldwide that many key surveying and construction manufacturers ask SECO to produce their own branded accessories. This has developed an important high-end OEM market, respected above the low cost / low quality manufacturers established in Asia. For years, the "Manufacturing by Seco" label has been recognized for quality that has never been surpassed.



The SECO facilities at Redding, CA, were threatened by the 2018 California wildfires. However, we came through and our staff thanks everyone for their support and generosity towards us during our brief shutdown.

SECO product managers are known for coming up with solutions for any kind of field requirement to meet customer needs. SECO products are available through dealers in almost every continent.

Precision manufacturing, quality focus, and skilled workmanship provide consistency to always meet and exceed customers' expectations. SECO's continued goal is to be the best accessories supplier for the surveying and construction markets. This ongoing mission will ensure that investing in SECO brand products will remain the smartest investment for productivity and longevity in the field.

SECO, based in California, USA, with facilities in Redding, Tecate, CA and Mexico, controls all facets of its manufacturing business. SECO's 82,500 square-foot manufacturing plant in Redding houses our company headquarters, customer service team, engineering, research and development, and a complete manufacturing facility. The facilities include anodizing, electrostatic powder-painting, and silk-screening departments, as well as a state-of-the-art machine shop.

In 2013, SECO acquired GeoDesy, a company based in Hungary that is well-known for designing and manufacturing high-end tribrachs to the survey and construction industries.

Rounding out the SECO inventory, we also offer entry-level third-party manufactured products for those customers who do not have the budget or need for long-lasting SECO manufactured products. Contact your SECO representative about all the products found in this catalog, to stock the best combination of products for your accessory needs.







## Tripods: GNSS/MC

Standard and Heavy Duty, with telescoping legs



### FEATURES & BENEFITS

- ▶ 5119-00 version offers dual graduations, collapsible center staff with a screw clamp mechanism and includes removable 5/8 x 11 adapter, and an on-board compass
- ▶ Both the 5115-00-XXX series and the 5119 series have a fixed-height, 2-meter center staff that rotates 360° for calibrating the included 8-minute vial
- ▶ All aluminum hardware is anodized black for long life
- ▶ 5119-10 features large telescoping legs (1.25 to 1.5 inch diameters) feature adjustable handle levers on the leg pivots and a large 6-inch diameter round head which easily holds lasers or robots
- ▶ All three tripods feature extendable electrostatically powder painted legs and include replaceable points

PART NO.	LOCKING	HEIGHT	COLLAPSES	COLOR	WEIGHS	
5115-00-FLY	Quick Clamp	2 m	2 m	Flo Yellow	>15.00 lb (6.80 kg)	
5115-00-YEL	Quick Clamp	2 m	2 m	Yellow	>15.00 lb (6.80 kg)	
5119-10-FLY	Screw Clamp	1.5, 1.8, 2 m	55 inches (1.4 m)	Flo Yellow	>30.00 lb (9.07 kg)	
5119-10-YEL	Screw Clamp	1.5, 1.8, 2 m	55 inches (1.4 m)	Yellow	>30.00 lb (9.07 kg)	
5119-00-FLY	Quick Clamp/Screw Clamp	1.5, 1.8, 2 m	50 inches (1.27 m)	Flo Yellow	>15.00 lb (6.80 kg)	
5119-00-FOR	Quick Clamp/Screw Clamp	1.5, 1.8, 2 m	50 inches (1.27 m)	Flo Orange	>15.00 lb (6.80 kg)	
5119-00-YEL	Quick Clamp/Screw Clamp	1.5, 1.8, 2 m	50 inches (1.27 m)	Yellow	>15.00 lb (6.80 kg)	





## Network Adapters

Professional Stainless Steel 303 CORS monument adapters



### FEATURES & BENEFITS

- ▶ Adapters in the 2072-Series have 3.20-in (8.19-cm) diameters and overall heights of 3.036-in (7.71-cm)
- ▶ Adapters are leveled by three screws with a tilt range +/- 7°
- ▶ Made of 303 SS and brass
- ▶ Includes a removable brass 5/8 x 11 male stud that is adjustable in azimuth and held in location by two set screws
- ▶ The axis height is engraved on the outside of the monuments
- ▶ Height above the pivot point to stud shoulder is 1.37-in (3.50-cm)
- ▶ Height below the brass 5/8 stud to shoulder is 0.463-in (1.18-cm)

PART NO.	FITS	COMPATIBLE WITH	WEIGHS	
2072-30	MPT 1-1/2 x 11-1/2 TPI	1.5-inch pipe	5.50 lb (2.50 kg)	
2072-31	MPT 2 x 11-1/2 TPI	2-inch pipe	6.60 lb (3.00 kg)	
2072-32	MPT 3-1/2 x 8 TPI	3-inch pipe	6.90 lb (3.10 kg)	
2072-33	MPT 5/8 x 11 TPI		6.20 lb (2.80 kg)	
2072-050	40-minute leveling vial		0.30 lb (0.14 kg)	

### Radio Antenna Tripod



#### FEATURES & BENEFITS

- ▶ Radio antenna tripod with antenna mast gets your radio antenna to the desired height
- ▶ Telescoped to 7.5-ft (2.3-m) and the tripod can be set to 5.5-ft (1.7-m) for a total elevation of 13-ft (4-m)

- ▶ Aluminum with a male 5/8 x 11 tip
- ▶ Hardwood/Fiberglass tripod is SECO's 5302-13-ORG
- ▶ Aluminum tripod is SECO's 5301-21-ORG

- ▶ The antenna mast can be purchased separately to convert your own heavy-duty tripod as well
- ▶ Weighs 19.00 lb (8.62 kg)

5561-20 — Radio Antenna Mast Assembly  
 5300-11 — Hardwood/Fiberglass  
 5300-12 — Aluminum (shown)



### Hands Free Tablet Harnesses

Provide Secure Hands-free Operation During Field Use



5200-95



5200-96

#### FEATURES & BENEFITS

- ▶ When purchased with the correct tablet bracket, each of these harnesses provide reliable hands-free operation
- ▶ Over one shoulder model allows for easy on/off operation (5200-95)
- ▶ Two-shoulder model allows for tighter movement and helps reduce fatigue for day-long operation (5200-96)
- ▶ Ball-and-Socket designs allows a tablet to be in multiple positions and very easy to adjust

- ▶ Mounts to tablet bracket using standard 1-1/2 inch ram ball connection
- ▶ 5200-95 and -96 come with 1-1/2 inch RAM ball
- ▶ Mount is made from a 0.080-inch (2.03-mm) black powder-coated aluminum sheet metal
- ▶ Weights: 5200-95 1.95 lbs, 5200-96 1.9 lbs
- ▶ Tablet brackets allow all ports, connections, and antenna to be accessible with the bracket attached

#### APPLICATIONS

- ▶ GNSS/Robotic surveying
- ▶ Construction Layout
- ▶ Road and highway surveys
- ▶ GIS Surveys

#### FOR TABLETS THAT HAVE THE QUICK RELEASE BRACKET ATTACHED

BRACKET PART NO.	FIT	
5200-39-051	Yuma 2/Yuma 7	
5200-40-051	Kenai/T-10	
5200-42-051	FZ-G1 With Radio	
5200-44-051	TSC7/Ranger7	

#### COMPLETE WITH TABLET BRACKET AND RAM LINK

BRACKET PART NO.	FIT	
5200-29-051	FZ-M1	
5200-30-051	FZ-G1/CS35	
5200-31-051	Getac T800	
5200-35-051	Tesla , Mesa 2/3/FC 5000/RT3/4	
5200-37-051	Yuma 2, 7" Rugged Tablet	
5200-38-051	Kenai, 10" Rugged Tablet	
5200-41-051	FZ-G1 with Radio	
5200-41	FZ-G1/CS35 with Radio, Ram	

Note: Tablet not included. Brackets sold separately.



5200-39-052

5200-95 — One Shoulder Tablet Harness  
 5200-96 — Two Shoulder Tablet Harness  
 5200-39-052 — Quick Release Bracket Adapter



### Pole Clamp: Ball and Socket Tablet

Virtually unlimited positions on the pole keeps the glare off the collector





5200-35

#### FEATURES & BENEFITS

- ▶ Pole Clamp locks securely to the pole, no slipping!
- ▶ All ports, connections, and camera are accessible and usable with the bracket attached

- ▶ Easy "snap in/out" design holds the tablet securely
- ▶ Compatible with add-on keyboard and extended battery
- ▶ Made from a single, solid 0.080 inch (2.03 mm) aluminum sheet metal

- ▶ Features ram ball links which allow many positions
- ▶ The 5200-35 features a 1-inch ram ball – the Ball-and-Socket versions allow the data collector to be in more positions

PART NO.	WORKS WITH	
5200-30	Panasonic FZ-G1/Leica CS35 (Not for Radio Models)	
5200-31	Getac T800	
5200-35	Tesla , Mesa 2/3, FC 5000, RT3/4	

### Cradles: Claw Ball and Socket

Design your own custom solution with one bracket and one cradle



5200-16-050



5200-29-050

#### FEATURES & BENEFITS

- ▶ These Claw™ clamps are made of durable anodized aluminum
- ▶ The Claw technology allows maximum tightening without crushing

- ▶ Features a 1-inch ram ball – the Ball-and-Socket versions allow the data collector to be in more positions

- ▶ Use with 5200-201 Ball and Socket Link, and 5200-160 or 5199-052 Pole Clamp

PART NO.	WORKS WITH	TYPE	
5200-16-050	TSC3, Ranger 3 Series	Claw	
5200-17-050	Mesa/Tesla	Snap In/Out	
5200-29-050	Panasonic FZ-M1, B2	Snap In/Out	

### Pole Clamp: Tablet Quick Release

Secure connection to your survey pole and tablet during field use







5200-33

#### FEATURES & BENEFITS

- ▶ Pole Clamp locks securely to the pole, no slipping!
- ▶ Tilting Feature with three positions, +10, +30 or +50 degrees

- ▶ Quick Release from Pole Clamp for taking photos, etc. and also allows Landscape or Portrait orientation of the Display
- ▶ All ports, connections, and camera are accessible and usable with the bracket attached

- ▶ Easy "snap in/out" design holds the tablet securely
- ▶ Compatible with add-on keyboard and extended battery
- ▶ Made from a single, solid 0.080 inch (2.03 mm) aluminum sheet metal, powder-coated black

PART NO.	MODEL	TABLET SIZE	
5200-32	Panasonic FZ-M1	7 inch (17.78 cm) tablet	
5200-33	Panasonic FZ-G1/Leica CS35	10 inch (25.4 cm) tablet	
5200-42	Panasonic FZ-G1/Leica CS35 with Radio	10 inch (25.4 cm) tablet	
5200-43	T-10 with Radio Quick Release		



### Claw Cradles: Quick Release

Design your own custom solution with one bracket and one cradle



#### FEATURES & BENEFITS

- ▶ The Claw™ is a clamping system featuring an innovative clamping device that keeps your expensive data collecting hardware snug on the pole

- ▶ The Claw cradles and clamps are made of durable anodized aluminum for years of trouble-free use in the field

- ▶ Quick-Release cradles plug directly in to Quick Release Pole Clamps

PART NO.	WORKS WITH	
5200-050	TSC2, Ranger 300X, 500X, FC 2500	
5200-058	FC-200, FC-250	
5200-059	Nomad 800-900 Series	
5200-062	Carlson Surveyor, Surveyor +, GIS-1	
5200-064	Geo 6000 Series, Geo 7X	
5200-065	TSC3, Ranger 3 Series	
5200-069	FC236, X7, PS236, PS336	
5200-070	Juno 5 / Juno T41 Series, Slate	
5200-072	Mesa Tesla	
5200-073	Archer 2, Mini2, FC 500	
5200-074	Allegro 2, Allegro 3, Surveyor 2	
5200-075	Nautiz X8, Nautiz X9	
5200-076	Panasonic Toughpads FZ-M1, B2 (Not Claw – “Snap in”)	
5200-077	Mesa 2/3, FC 5000, RT3/4 (Not Claw – “Snap in”)	

### Ball-and-Socket and Claw Accessories

Perfect for creating a custom solution

- ▶ Fits any standard instrument tripod
- ▶ Use with a 5200-201 Ball-and-Socket Link and a Ball-and-Socket Cradle (designed for your data collector) for a complete system



5199-051 — Tripod Mount

- ▶ Fits any standard instrument tripod
- ▶ Use with a 5200-201 Ball-and-Socket Link and a Ball-and-Socket Cradle (designed for your data collector) for a complete system



5199-054 — Suction Cup (temporary mount)

- ▶ Use the Ball-and-Socket Link for your custom solution
- ▶ Fits the 1-inch ram ball on cradles and clamps



5200-201 — Ball-and-Socket Link

- ▶ Mount your data collector or controller to this ball clamp and the handle bars of your ATV



5199-050 — ATV Ball Clamp

- ▶ Pole Clamp with 1-inch (32 mm) Ram Ball
- ▶ Fits poles with an outside diameter of 0.75-inches to 1.5-inches



5199-052 — Ram Ball Clamp Mount



## Pole Clamps and Cradles

Design your own custom solution with clamp and cradle



5198-056

### FEATURES & BENEFITS

- ▶ Original Open-Style Pole Clamp technology for a complete solution
- ▶ Use a Claw Quick-Release cradle or clamp for a complete solution

- ▶ Made of black anodized aluminum
- ▶ Depressing the quick-release button will allow the Claw Quick-Release cradle or clamp to rotate in to a comfortable position for reading the data

- ▶ collector or controller
- ▶ Features a quick-release button and a stainless steel clamp screw that attaches to the pole
- ▶ Designed for standard poles or rods with a 0.75 to 1.25-inch OD





















5198-153



5200-160



5198-073

PART NO.	Quick Release Open-Style Clamps (for 1.25-inch OD pole)	
5198-052	Plain	
5198-054	40-minute Vial	
5198-055	Compass	
5198-056	Compass and 40-minute Vial	
5198-059	0.15 x 0.92-inch Slot	
5198-152	For 1.5-inch OD Pole	
5198-153	Battery Slot with Quick Release	
PART NO.	Claw Ball-and-Socket Clamps (for 1.25-inch OD pole)	
5200-160	Plain with 1" Ball	
5200-164	With Compass	
5200-165	With 40-minute Vial and Compass	
5200-166	Plain with 1.5" Ball	
PART NO.	Claw Quick Release Clamps (for 1.25-inch OD pole)	
5200-150	Plain	
5200-151	With 40-minute Vial	
5200-152	With 20-minute Vial	
5200-154	With Compass	
5200-155	With 40-minute Vial and Compass	
PART NO.	Quick Release Cradles	
5198-073	Nautiz N7, DAP 9800, SDR33, Titan	
5198-081	PDA	

## Quick Release Cradle



5198-086

### FEATURES & BENEFITS

- ▶ 5198-086 cradle requires Leica pole bracket, any model. This modifies the Leica pole bracket to work with SECO poles.

- ▶ Requires a SECO quick-release pole bracket

5198-086 — Quick Release Cradle for Leica Pole Bracket



### Tripod Data Collector Brackets

- ▶ The open clamp attachment allows quick and easy connection to the pole; it connects to 1-to-1.25-inch (25.4 to 31.8-mm) OD poles
- ▶ Brass male 5/8 x 11 captive stud is easily removed for direct attachment of the radio antenna to the bar
- ▶ Includes a non-slip Velcro® cable strap to help manage radio cables
- ▶ Weighs 0.22 lb (0.10 kg)

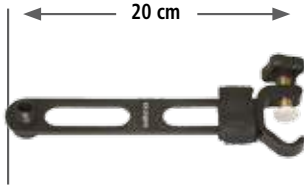

2133-03 — Antenna Bracket

- ▶ Bracket holds a radio antenna securely to a tripod leg
- ▶ The heavy-duty bracket makes plumbing the antenna easy
- ▶ Fits all full-size and heavy-duty tripods and uses a 1/2-inch long, 5/8 x 11 male stud to secure the antenna or extension (tripod sold separately)
- ▶ Can be used with the SECO Six Foot Snap-Lock Radio Antenna Pole (5139-02, page 13) or any extension with a male/female 5/8 x 11 connection
- ▶ Weighs 1.55 lb (0.70 kg)



2133-05 — Radio Antenna Bracket for Tripod

- ▶ Easy installation and removal
- ▶ Adjust location on tripod leg for your convenience
- ▶ Powder painted aluminum
- ▶ Weight 0.40lbs / 0.18kg



5196-22 — Tripod Hook TSC7 / Ranger 7

- ▶ Designed to fit precisely on the back of the controller
- ▶ Works with most heavy-duty tripods that feature a connecting bar on the hinge area



Tripod Hook Brackets Designed for  
 5196-17 — Nomad   
 5196-18 — TSC3 or Ranger 3   
 5196-19 — Mesa Tesla   
 5196-20 — Archer 2

- ▶ Holds the Allegro 1-3, Archer®, Explorer, Recon® or Jett®•ce



5196-07 — Tilted Bracket

- ▶ Easily holds a laptop computer
- ▶ Measures: 13 x 10.25 in (33 x 26.04 cm)



5196-02 — Laptop Bracket

### Two-Piece GNSS Rover Rods

Two-piece is easy to set up and convenient to store and transport



#### FEATURES & BENEFITS

- ▶ Lightweight two-piece rover rods come in aluminum or carbon fiber and feature 5/8 x 11 tips (5125-01-YEL features a quick-release adapter) and 40-minute vials
- ▶ Outer graduations options are 10ths/100ths (GT), metric (GM) or Quick Release (QR)
- ▶ 5125-06-YEL and 5128-08 feature a cable management slot measuring 0.625 x 1.6-in to hide cables

- ▶ Order 8162-00-ORG for carrying case

PART NO.	POLE	TIP	CABLE SLOT	OUTER GRADS	LENGTH	WEIGHS	
5125-00-YEL	Aluminum	5/8 x 11	No	10ths/100ths (GT)	2 meters	3.00 lb (1.36 kg)	
5125-01-YEL	Aluminum	Quick Release	No	None	2 meters	3.00 lb (1.36 kg)	
5125-06-YEL	Aluminum	5/8 x 11	Yes	10ths/100ths (QR)	2 meters	3.00 lb (1.36 kg)	
5128-00	Carbon Fiber	5/8 x 11	No	10ths/100ths (GT) or Metric (GM)	2 meters	1.42 lb (0.64 kg)	
5128-08	Carbon Fiber	5/8 x 11	Yes	10ths/100ths (GT, QR)	2 meters	1.42 lb (0.64 kg)	

## Telescopic Carbon Fiber Rover Rods

Carbon fiber rover rods are 30% lighter







### FEATURES & BENEFITS

- ▶ Designed so the GNSS surveyor has all the features needed in a single rod
- ▶ Zero height, reads direct

- ▶ The included pin can lock the length of the rod at set points
- ▶ TLV™ locking mechanism comes standard

- ▶ Carbon fiber makes these rods 30% lighter
- ▶ Order 8160-00-ORG for carrying case

PART NO.	GRADS	LENGTH	Outer Grads	PIN LOCKING	WEIGHS	
5129-50	Dual (10ths/2 mm)	4.48 ft (1.4 m) - 8.14 ft (2.45 m)	10ths/100ths (GT)	1.8 m, 2 m, 2.2 m	2.30 lb (1.05 kg)	
5129-51	Metric/2 mm	4.48 ft (1.4 m) - 8.14 ft (2.45 m)	None	1.8 m, 2 m, 2.2 m	2.30 lb (1.05 kg)	
5129-70	Dual (0.05 ft/cm)	4.69 ft (1.43 m) - 11.7 ft (3.57 m)	None	Every 20 cm	3.30 lb (1.50 kg)	
5129-71	Metric	4.69 ft (1.43 m) - 11.7 ft (3.57 m)	None	Every 20 cm	3.30 lb (1.50 kg)	

## Snap-Lock Rover Rods

Easy set up









### FEATURES & BENEFITS

- ▶ Includes a one-piece design and two locking systems for stability
- ▶ Zero height, reads direct
- ▶ The snap lock prevents slippage and the compression lock

- centers the telescopic inner pole and maintains straightness
- ▶ Telescoping rods include standard locking lengths and also have OPTIONAL outer graduations in metric (GM), 10ths/100ths (GT)

- ▶ Your choice of either aluminum or carbon fiber rod includes a 40-minute vial
- ▶ Order 8160-00-ORG for standard case
- ▶ Order 8151-02-FLY system bag (tripod or bipod)

PART NO.	POLE	OPTIONAL OUTER GRADS	LOCKING LENGTHS	WEIGHS	
5125-20-FLY	Aluminum	10ths/100ths (GT) or Metric (GM)	2 m	2.30 lb (1.05 kg)	
5125-20-YEL	Aluminum	10ths/100ths (GT) or Metric (GM)	2 m	2.30 lb (1.05 kg)	
5125-22-FLY	Aluminum	10ths/100ths (GT)	2, 1.8, 1.6 m	2.30 lb (1.05 kg)	
5128-20	Carbon Fiber	10ths/100ths (GT), Metric (GM)	2 m	1.60 lb (0.73 kg)	
5128-22	Carbon Fiber	10ths/100ths (GT) or Metric (GM)	2, 1.8, 1.6 m	1.60 lb (0.73 kg)	
5128-24	Carbon Fiber	Standard only	1.8, 1.6 m	1.60 lb (0.73 kg)	

## Quick Change Prism Poles

Vials are on the locks, out of the way of instruments on the pole











### FEATURES & BENEFITS

- ▶ Compatible with all targets, prisms, and GNSS antennas
- ▶ Using adapters, any of the poles in this series can be used for GNSS, robotics or total station surveys

- ▶ Metric Centimeter Graduations
- ▶ Quick conversion to another application by changing adapters (sold separately, see below)
- ▶ TLV™ (Twist-Lock with Vial) locking mechanism includes a

- 40-minute vial
- ▶ Available with locking pin & holes (the locking system guarantees no slipping of the sections)
- ▶ Carbon fiber and aluminum models offered

PART NO.	GRADUATED LENGTH	OUTER POLE	LOCKING PIN	ADAPTER INCLUDED	
5527-10	1.33 to 2.20 m	Aluminum		2090-12	
5527-11	0.50 to 0.70 m	Aluminum		2090-12	
5527-13	1.33 to 2.20 m	Carbon Fiber	@ 1.4, 1.6, 1.8, 2.0, 2.2M	2090-12	
5527-15	1.51 to 2.60 m	Aluminum		2090-12	
5527-16	1.51 to 2.60 m	Carbon Fiber	@ 1.8, 2.0, 2.2, 2.4, 2.6M	2090-12	
5527-17	1.58 to 3.60 m	Carbon Fiber	@ 1.8, 2.0M	2090-12	
5527-20	1.58 to 3.60 m	Aluminum		2090-12	
5527-22	1.58 to 3.60 m	Carbon Fiber	@ 1.8 to 3.6M every .2M	2090-12	
5527-30	1.65 to 4.65 m	Aluminum		2090-12	

### Aluminum Pole Series with Locking Pins, Adapter

- ▶ Extends to 2.6M
- ▶ 0 Height, graduated in centimeters
- ▶ Locking pin holes at 1.8M, 2.0M, 2.2M, 2.4M, 2.6M
- ▶ 40' Vial
- ▶ Weight 3.15lbs ( 1.43kg)



Can easily be converted to different heights by using one of our Quick Change Pole Height Adapters

5512-13-FLY-GM — GNSS Model 



- ▶ Extends to 8.5ft
- ▶ 135MM Height, graduated in centimeters and .01ft
- ▶ Locking pin holes at 6.5FT, 7.0FT, 7.5FT, 8.0FT, 8.5FT
- ▶ 40' Vial
- ▶ Weight 3.15lbs ( 1.43kg)

Can easily be converted to different heights by using one of our Quick Change Pole Height Adapters

5512-14-FOR-GT — Robotic Model   
5512-14-FOR-GM — Metric Robotic Model 



- ▶ Adapts Swiss-style prism poles to 5/8 x 11
- ▶ Weighs 0.06 lb (0.03 kg)







2090-00 — Wild Prism Pole Adapter 

### Accessories for Robotics Gear

- ▶ 5/8 X 11 aluminum prism height adapters allow the base pole to be used with other manufacturers' 360° prisms



- 2090-01 — For Topcon Users w/ 77 mm Prism 
- 2090-02 — For Leica Users w/86 mm Prism 
- 2090-04 — Users w/115 mm Prism 
- 2090-06 — Convert Robotics to GNSS Pole (not shown) 
- 2090-07 — For Topcon ATP1/2 with 50 mm Prism 

- ▶ This lightweight bipod is used to keep a GNSS or robotic pole off the ground when not in use
- ▶ Weighs 0.90 lb (0.41 kg)



5217-15-ABK — 12 inch Open Clamp Bipod 

### 360° Robotic Prism Assembly

Copper-coated 35 mm prisms



#### FEATURES & BENEFITS

- ▶ Includes six 35 mm prisms
- ▶ 0 offset

- ▶ 77 mm prism height
- ▶ Copper-coated for moisture prevention

- ▶ Protective urethane bumper in yellow
- ▶ Designed for Topcon®

6401-00-YEL — 360° Robotic Prism Assembly 

### GNSS Accessories and Adapters

Converts any GNSS receiver or prism with 5/8 x 11 threads to a quick release

- ▶ Adapter features a female 5/8 x 11 quick release tip
- ▶ Made of anodized aluminum or optional Stainless Steel version
- ▶ Adds 23.8-mm (.937 inches) to length of rod
- ▶ Weighs 0.05 lb (0.02 kg)



5187-00 — GNSS Quick-Release Adapter   
5187-00-SS — GNSS Quick-Release Adapter (Stainless Steel) 

- ▶ Use with GNSS Quick-Release Adapter (5187-00)
- ▶ Made of anodized aluminum or optional Stainless Steel version
- ▶ Adapter adds 76.22-mm (.937 inches) to the pole length
- ▶ Weighs 0.14 lb (0.06 kg)



5111-00 — GNSS Quick-Disconnect Adapter   
5111-00-SS — GNSS Quick-Disconnect Adapter (Stainless Steel) 



## GNSS Accessories and Adapters cont.

Converts any GNSS receiver or prism with 5/8 x 11 threads to a quick release

- ▶ Anti-rotation quick-release assembly
- ▶ Heavy-duty construction, will hold up to 20 lb (9.00 kg)
- ▶ Short height, only 60 mm (2.5 inches)
- ▶ Constructed of quality stainless steel and aluminum
- ▶ Easy to operate, push button release
- ▶ Includes one (1) 5111-04-051
- ▶ For extra 5111-04-051, order separately
- ▶ Weighs 0.35 lb (0.16 kg)



5111-04 — 60 mm Anti-Rotation Quick Release   
5111-04-051 — Male 5/8 





- ▶ Used to elevate a radio antenna to 6 feet plus the height of the tripod setup
- ▶ Snap locks into a fixed length of 6-feet (1.8-m)
- ▶ Collapses to 41.5-inches (1-meter)
- ▶ Includes a 3.5-inch (8.89 cm) OD plate adapter
- ▶ (5182-002) to attach to any 5/8 x 11 tripod heads
- ▶ Available in standard yellow of fluorescent yellow
- ▶ Weighs 1.40 lb (0.62 kg)



5139-02-FLY — 6 Foot Snap-Lock Radio Antenna Pole 

- ▶ The 5114-series allows quicker attachment of the GNSS antenna
- ▶ The 5114-10 is an extra-tall mag mount for use when attaching GNSS receivers with downward antennas
- ▶ Both magnets have a 3.5-inch (8.89cm) diameters (5114-050 and 5114-051)
- ▶ Each single has 120 lb. of pull on 1/2" steel plate
- ▶ 5114-050 or 5114-051 weigh 0.92 lb (0.42 kg)



5114-01 — Quick-Release Triple Mag Mount   
5114-02 — 5/8 x 11 Triple Mag Mount   
5114-10 — Triple Mag Mount for Trimble R10   
5114-050 — 5/8 x 11 Tip   
5114-051 — Quick-Release Tip 

- ▶ SECO's Tripod Radio Antenna Kit attaches easily to instrument tripods
- ▶ Tripod leg clamp will attach to any tripod leg and ram ball and socket section of clamp quickly. Sets the antenna pole up vertically
- ▶ A large washer is included to allow a straight connection to a tripod for a separate setup
- ▶ Kit consists of three antenna sections that set up the radio antenna pole height to 3.1 ft (0.95 m) above the tripod
- ▶ Kit bag measures 16 x 6 x 2-inches (40.6 x 15.2 x 5.8-cm)
- ▶ Weighs 1.90 lb (0.86 kg)



5133-06 — Tripod Radio Antenna Kit 

- ▶ Adapter has male 5/8 x 11 threads
- ▶ Weighs 0.08 lb (0.04 kg)



5113-012 — GNSS Quick-Release Tip 

- ▶ Designed to hold on to pipes, flip the switch to release its hold on metal surfaces
- ▶ Holds up to 132.20 lb (60.00 kg)
- ▶ Weighs 2.15 lb (0.98 kg)



5113-012 — GNSS Quick-Release Tip 

- ▶ All-Terrain Rover Rod "Big Wheel"
- ▶ Measures 19 x 1-5/8-inch (48.26 cm x 3.81 cm)
- ▶ Rod and Bipod are not included with Wheel
- ▶ Perfect for RTK profiling
- ▶ Weighs 3.80 lb (1.72 kg)



5125-056 — All Terrain Wheel 

Add Rover top section:  
5125-057-FLY — Aluminum Rod   
5128-052 — Carbon Fiber Rod 

- ▶ The Satellite Stick™ XL is composed of six, 1-in (25.4-mm) OD carbon fiber sections
- ▶ Collapses to 1.23-ft (37.5-cm)
- ▶ Includes carrying bag
- ▶ Weighs 2.40 lb (1.09 kg)



5126-10 — Satellite Stick XL 

- ▶ GNSS Compass for 1.25 inch (3.18 cm) diameter poles



5125-050 — GNSS Compass 

- ▶ Constructed from anodized aluminum



5120-00 — Tripod Adapter 3-1/2 x 8 to 5/8 x 11   
5130-00 — Tripod Adapter 5/8 x 11 to 3-1/2 x 8   
5132-01 — Tripod Adapter 5/8 x 11F to 1/4 x 20M 

### GNSS Bracket for Truck Door

Expands vertically from 47 to 61 inches



#### FEATURES & BENEFITS

- ▶ This bracket holds a GNSS pole to the door of your survey truck
- ▶ Easy to put on and take off and features a non-damaging mount
- ▶ 5114-20 fits most trucks and SUVs
- ▶ The door opens and closes with the bracket attached to the door
- ▶ Bracket holds all GNSS- and RTK type poles
- ▶ Utilizes a safety strap under tension to keep it on the door
- ▶ Brackets are available to hold controller inside the cab
- ▶ Designed for off-road use
- ▶ Both products available in colors FLY, FOR, YEL
- ▶ Weighs 6.20 lb (2.80 kg)

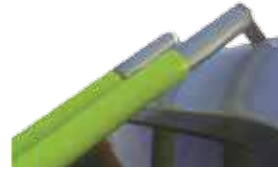
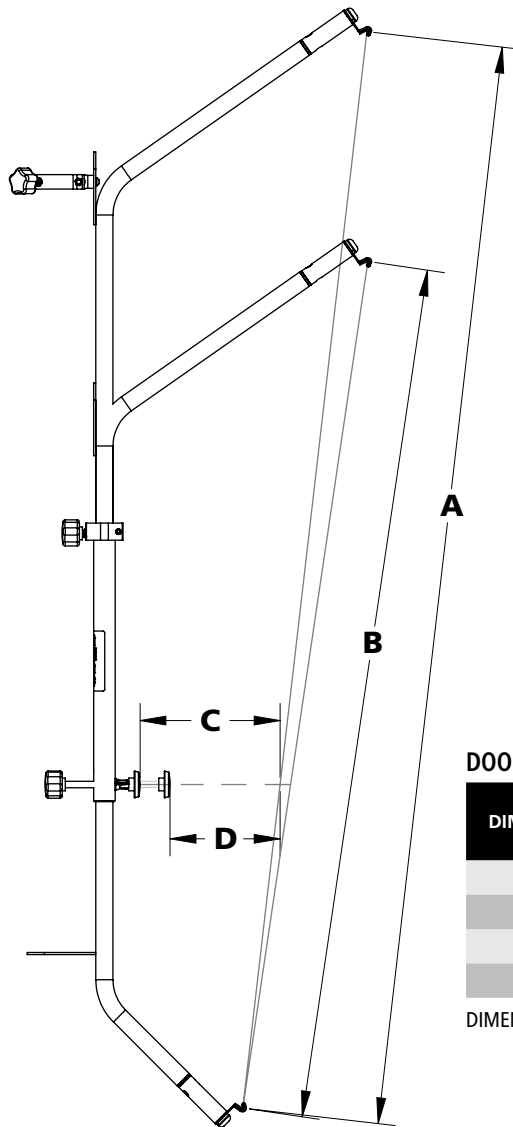

5114-20-051  
3-inch Extension Kit for Dodge and other truck models



5114-20-050  
Topo Shoe Adapter

#### DOOR FIT DIMENSIONS

DIMENSION	5114-20-XXX	5114-20-XXX W/ 5114-20-051 EXTENSION KIT	5114-21-XXX
A	4'-11" (59")	5'-3" (63")	4'-11" (59")
B	3'-10" (46")	4'-2" (50")	3'-10" (46")
C	6-3/8"	8-3/4"	7"
D	4-1/2"	6-1/2"	5"

DIMENSION TOLERANCE +/- 1/4"

5114-20-XXX — GNSS Bracket for Truck  
5114-21-XXX — Ford F-150 2015 & 2016 models



**UTV Roll Cage Transporter for GNSS Rods**

Easy set-up or disassembly in 10 minutes or less



**FEATURES & BENEFITS**

- ▶ The RUXWORKS GNSS Rod Transporter™ fits all popular UTVs
- ▶ Mounts easily to either side and installs in 10 minutes or less

- ▶ The UTV bracket has up to 30° of tilt to set your rover rod plumb
- ▶ The pole clamp section is 63-in (160-cm) long and disassembles quickly from the UTV bracket with two quick release pins or two bolts

- ▶ The UTV bracket can stay permanently attached to the UTV
- ▶ Includes a rod clamp that fits all popular rover rods and poles with points and/or topo shoes up to a 2-1/2-inch (6.35-cm) diameter

PART NO.	FITS	WEIGHS	
5114-40-01	Tubular Roll Cage up to 2-inches (5.08 cm)	15.00 lb (6.80 kg)	
5114-40-02	Rectangular Roll Cage up to 2 x 4-inch (5.8 x 10-cm)	15.00 lb (6.80 kg)	

**ATV Bracket for TSC7 / Ranger 7**



**FEATURES & BENEFITS**

- ▶ Works with ATVs, Snowmobiles, and Motorcycles
- ▶ Fits handlebars from 0.5 to 1.25 inches in diameter

- ▶ Two links included for different height location. Long Link 5.625", Short Link 3.5"
- ▶ Uses 1.5" balls for stable positioning holding
- ▶ Weighs only 1.4lbs 0.64kg



5198-52 – Bracket ATV, TSC7 / Ranger 7

**Plan Holder**

Conveniently organize and store job site materials in your vehicle



**FEATURES & BENEFITS**

- ▶ Plan holder hangs on the back or front of any vehicle seat
- ▶ Slots which hold four 6-inch (15.24 cm) diameter plans

- ▶ Front pocket accommodates a note pad, phone, or other small items
- ▶ Organizer strap holds pens, pencils, markers, and other necessary tools

- ▶ Weighs 0.95 lb (0.43 kg)

8046-10-BLU — Plan Holder

### Vials

#### Vial for TLV™ Locks



 **5500-064-40 - Vial Assembly**  
(Complete with 40-min vial)

-  40-Minute Vial D11232 Includes screws 
-  20-Minute Vial D11233 Includes screws 
-  8-Minute Vial D11234 Includes screws 

#### Vial for QLV™ Locks



 **5801-052-40 - Vial Assembly**  
(Complete with 40-min vial)

-  40-Minute Vial D11243 Includes screws 
-  20-Minute Vial D11242 Includes screws 
-  8-Minute Vial D11241 Includes screws 

#### Vial for 1.25-inch OD Pole Levels



 **5081-052-40 - Vial Assembly**  
(Complete with 40-min vial)

-  40-Minute Vial D11232 Includes screws 
-  20-Minute Vial D11233 Includes screws 
-  8-Minute Vial D11234 Includes screws 

#### Vial for 1.50-inch OD Pole Levels



 **5070-051-40 - Vial Assembly**  
(Complete with 40-min vial)

-  40-Minute Vial D11232 Includes screws 
-  20-Minute Vial D11233 Includes screws 
-  8-Minute Vial D11234 Includes screws 

### Levels

- ▶ No longer need to look down while traffic is flying by — simply look through the window
- ▶ Features a soft rubber knob on an adjustable clamp that fit most survey poles and most vials
- ▶ The Heads-Up™ level is more comfortable to read; the bubble is direct reading
- ▶ Fits 1- to- 1.25-inch (25.4- to- 31.75-mm) OD poles
- ▶ Weighs 0.40 lb (0.18 kg)



5001-20 — Heads-Up™ Level - 40-minute Vial 

- ▶ Features a die-cast aluminum body and adjustable vial
- ▶ Use with track light, robotic instruments, or conventional leveling
- ▶ Fits round or rectangular rods
- ▶ Feature a 40-minute sensitivity
- ▶ Weighs 0.50 lb (0.22 kg)



5001-10 — Standard Rod Level 

- ▶ Features a die-cast aluminum body and adjustable vial
- ▶ Suitable for use with track light, robotic instruments, or conventional leveling
- ▶ Fits round or rectangular rods
- ▶ Fits poles with a 1- to- 1.25-inch (25.4- to- 31.75-mm) OD
- ▶ Feature a 40 minute sensitivity vial
- ▶ Weighs 0.10 lb (0.04 kg)



5001-12 — Snap-On Rod Level 



### Scanner Spheres



**FEATURES & BENEFITS**

- ▶ 100 mm OD lightweight aluminum sphere
- ▶ Precision design, allowable deviation < 1 mm

- ▶ Female 1/4 x 20 threaded mounting
- ▶ Painted non-glare white
- ▶ Weighs 0.60 lb (0.27 kg)

- ▶ Center height is 49 mm from bottom flat
- ▶ Height adapters: 6703-005 or 6703-002 see page 18

6703-001 — 100 mm Scanner Sphere

**FEATURES & BENEFITS**

- ▶ Lightweight aluminum scanner sphere
- ▶ 230 mm diameter, accuracy < 2 mm

- ▶ Female 5/8 x 11 threaded mounting
- ▶ Painted non-glare white
- ▶ Center height is 114 mm from bottom flat

- ▶ Weighs 2.70 lb (1.22 kg)
- ▶ To order a drawstring carrying pouch: PN D12560 (for 230 mm)

6704-001 — 230 mm Scanner Sphere

### Sphere Adapters, Accessories and Case

- ▶ 3-7/8 inch diameter housing
- ▶ 3-1/2 inch ceramic grade 5 magnet
- ▶ 120 pounds of pull force
- ▶ Stainless steel 5/8 x 11 stud
- ▶ Height is 21 mm
- ▶ Weighs 0.95 lb (0.43 kg)



6704-002 — Magnet with 5/8 x 11 Stud

- ▶ Anodized aluminum body
- ▶ Male and female 5/8 x 11 threads
- ▶ Height is 21 mm
- ▶ Center height is 135 mm with 230 mm Sphere (6704-001)
- ▶ Weighs 0.05 lb (0.02 kg)



6704-003 — 21 mm Male and Female 5/8 x 11 Adapter

- ▶ Anodized aluminum body
- ▶ Male and female 5/8 x 11 threads
- ▶ Height is 48 mm
- ▶ Center height is 196 mm with 230 mm Sphere (6704-001) and Tribrach Adapter (2070-00)
- ▶ Weighs 0.10 lb (0.04 kg)



6704-004 — 48 mm Male and Female 5/8 x 11 Adapter

- ▶ Includes three 230 mm scanner spheres in a hard case
- ▶ Includes cover bag for each sphere for insulation and scratch protection
- ▶ Airline approved shipping case
- ▶ Weighs 17.60 lb (7.98 kg)



6704-10-CASE — Carrying Case solo   
 D12560 — Cloth cover for the 230 mm sphere   
 6704-10 — Hard Case and three (3) 230 mm Scanner Spheres

- ▶ 3/8 x 16 stainless steel male stud
- ▶ Three prong tribrach interface connection
- ▶ Height is 60.5 mm
- ▶ Height to target with the TX5 / FARO3D achieves 196 mm
- ▶ Weighs 1.35 lb (0.61 kg)



6703-011 — 196 mm HT Tribrach Adapter for TX5/FARO3D

- ▶ "Quick Release Adapter" specifically for Trimble TX5 and Faro Focus 3D scanners
- ▶ Quick and safe connection between the scanner instrument and a Gitzo or any tripod with a male 3/8 x 16 thread
- ▶ Rotates smoothly on Delrin® bearing for orientating the instrument

- ▶ Clamp screw is captured and protected from damage
- ▶ Anodized aluminum and stainless steel materials
- ▶ Base has a setscrew to lock base to tripod head
- ▶ Built-in 100-minute level vial on base
- ▶ Weighs 0.70 lb (0.32 kg)



6703-015 — Quick Release Adapter for Trimble TX5 and Faro Focus 3D

### 100 mm Sphere Prisms, Adapters, Magnets and Kits

- ▶ Lightweight aluminum sphere and ceramic grade 8 magnet
- ▶ Steel cup OD 2.03 inches
- ▶ Stainless steel 1/4 x 20 stud
- ▶ Center height: 72.5 mm
- ▶ Magnet is chrome coated

- ▶ steel cup and offers 40 pull pounds
- ▶ 100 mm OD roundness <1 mm
- ▶ 1/4 x 20 threaded mounting
- ▶ Painted non-glare white
- ▶ Weighs 0.80 lb (0.36 kg)



**6703-10 — 100 mm Scanner Sphere with Magnet** 

- ▶ 1/4 x 20 stainless steel male stud
- ▶ 5/8 x 11 female connection
- ▶ Height is 23.5 mm
- ▶ Height to target with 100 mm sphere achieves 72.5 mm
- ▶ Weighs 0.05 lb (0.02 kg)



**6703-005 — 5/8 x 11, 72.5 mm HT Adapter** 

- ▶ 25 mm silver-coated prism
- ▶ -17.5 mm offset
- ▶ Length is 72.5 mm prism center to connections
- ▶ 5/8 x 11 female and magnetic connection
- ▶ Weighs 0.75 lb (0.34 kg)



**6703-012 — 72.5 HT Prism Assembly with Magnet** 

- ▶ Rubber tips on stainless-steel legs prevent scratching of delicate surfaces
- ▶ Folding legs make tripod very portable
- ▶ Made of anti-corrosive materials
- ▶ Steel-plated washer atop tripod easily attaches to scanner sphere
- ▶ Height is 39 mm
- ▶ Weighs 0.15 lb (0.07 kg)
- ▶ (Sphere not included)



**6703-008 — Scanner Sphere Mini Tripod** 

- ▶ 6703-20 includes six 100 mm scanner spheres and six magnets with 1/4 x 20 studs
- ▶ Sphere center height with magnet: 72.5 mm
- ▶ Weighs 6.60 lb (3.00 kg)



**6703-20 — 6 piece 100 mm Sphere Kit includes Soft Case** 

- ▶ Compatible with the TX5
- ▶ Width is 3.12 in (79.3 mm)
- ▶ Height is 34 mm
- ▶ Weighs 1.75 lb (0.80 kg)



**2070-02 — 3/8 x 16 Tribrach Adapter** 

- ▶ Zinc-plated steel material
- ▶ 1.90 in (48.26 mm) in diameter
- ▶ Thickness is 0.098 in (2.5 mm)
- ▶ 0.24 in (6 mm) countersink hole connection
- ▶ Weighs 0.05 lb (0.02 kg)



**6703-007 — Wall Washer Adapter** 

- ▶ Brass washers centers to 6703-002 magnet base connection
- ▶ 90 pounds of pull force
- ▶ Connects to pipes and flat surfaces
- ▶ Weighs 0.90 lb (0.41 kg)

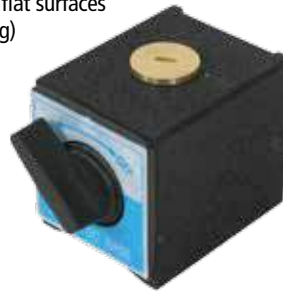

**6703-013 — V-Base with Washer Magnet** 

- ▶ Stainless steel 1/4 x 20 stud
- ▶ Chrome-plated steel cup
- ▶ 2.03 inch OD steel cup
- ▶ Grade 8 ceramic magnet
- ▶ Center height when using the 6703-001 is 72.5mm
- ▶ 40 pounds (18.14 kg) of pull force
- ▶ Weighs 0.20 lb (0.09 kg)



**6703-002 — Magnet with 1/4 x 20 Stud** 

- ▶ Pelican® hard shell case features custom foam keeping spheres, prisms, adapters, etc., safe and secure
- ▶ 6703-11 includes ten 100 mm scanner spheres and ten magnets with 1/4 x 20 studs
- ▶ Dimensions: 24.5 x 19 x 9 in (62.3 x 48.3 x 22.9 cm)
- ▶ Weighs 22.00 lb (10.00 kg)



**6703-11 — 10 piece 100 mm Sphere Kit includes Hard Case** 

- ▶ Six padded compartments (for 100 mm spheres, sold separately)
- ▶ Made from 1000D Cordura with 2 inch padded foam and includes a carrying handle
- ▶ Stowable straps (cases can connect together)
- ▶ Outside Dimensions: 16 x 11 x 8 in (40.64 x 27.94 x 20.32 cm)
- ▶ Inside Dimensions: 13 x 9.5 x 4 in (33.02 x 24.13.94 x 10.16 cm)
- ▶ Weighs 2.00 lb (0.91 kg)



**8082-01-ORG — Soft Case for 100 mm Scanner Spheres** 

- ▶ Pelican® hard shell case features custom foam keeping spheres, prisms, adapters, etc., safe and secure
- ▶ Same dimensions as 6703-11
- ▶ Weighs 14.00 lb (6.36 kg)



**6703-014 — Pelican Case for 100 mm Spheres (spheres sold separately)** 

### Scanner Targets



**FEATURES & BENEFITS**

- ▶ Adjustable tilting target, for affixing to pole top and used in multiple survey jobs.

- ▶ Contrasting 6" (152mm) Black and White pattern
- ▶ Matte non-glare target material
- ▶ Adjustable tilting axis

- ▶ Anodized aluminum yoke and target plate
- ▶ Axis height 135mm
- ▶ 5/8-11 threaded base
- ▶ Weight 0.90 lbs, 0.41kg

6705-10 — Target, Tilting, 6" B/W



**FEATURES & BENEFITS**

- ▶ Easy-to-use self-adhesive target, which can be fixed to measuring points.
- ▶ Ideal for monitoring work where you have to leave targets in position over long periods.

- ▶ Contrasting 6" (152mm) Black and White pattern
- ▶ Matte non-glare target material
- ▶ Material is 3M 3.2-mil vinyl films with a pressure-sensitive adhesive and air release channels for easier, bubble-free application. Easy to remove,

- ▶ leaves no adhesive.
- ▶ Weather resistant and UV stable.
- ▶ Space to mark target ID
- ▶ Adhesive backed
- ▶ Package weight: 0.25 lbs (0.11 kg)

6705-20 — Target, Adhesive, 150X200mm, B/W, 10pk

### Carbon Fiber Robotics Poles

Features carbon fiber and TLV locking mechanism



**FEATURES & BENEFITS**

- ▶ Graduated to read direct for a 135 mm prism height
- ▶ Adapters will achieve other prism heights

- ▶ Carbon fiber pole offers a stainless steel pin which locks the inner pole
- ▶ Features TLV™ lock mechanism with 40-minute vial built-in

- ▶ Optional outer graduations in metric (GM) or 10ths/100ths (GT)
- ▶ Order 8160-00-ORG for carrying case

PART NO.	GRADS	SECTIONS	PIN LOCKING	OUTER GRADS	LENGTH	WEIGHS	
5129-52	Dual	1	Every 0.5 ft	10ths/100ths (GT)	4.97 ft - 8.53 ft	2.30 lb (1.04 kg)	
5129-53	Metric	1	Every 20 cm	Metric (GM)	1.53 m - 2.6 m	2.30 lb (1.04 kg)	
5129-72	Dual	2	Every 0.5 ft	None	5.18 ft - 11.81 ft	3.30 lb (1.50 kg)	
5129-73	Metric	2	Every 20 cm	None	1.58 m - 3.6 m	3.30 lb (1.50 kg)	

### Telescopic Carbon Fiber Prism Pole

Carbon fiber poles are approximately 30% lighter than similar aluminum poles



**FEATURES & BENEFITS**

- ▶ Adjustable tip that will adjust to a prism height of 65 mm to 115 mm

- ▶ TLV locking and dual graduations and OD is 1.27 in (32 mm)
- ▶ Extends 8.53 ft (2.60 m)

- ▶ Collapses to 4.97 ft (1.51 m)
- ▶ Weighs 2.30 lb (1.05 kg)

5129-54 — Adjustable Tip Carbon Fiber Pole

### Mini Poles

Compact, easy to set up, and convenient to store and transport



#### FEATURES & BENEFITS

- ▶ Mini poles are easy to use
- ▶ Adjustable or fixed-tip poles
- ▶ Light weight and convenient to transport and store
- ▶ 40-minute bubble vials
- ▶ Powder-coated and silk screened aluminum

PART NO.	HEIGHT	GRADS	LOCK TYPE	PRISM HEIGHT	WEIGHS	
5500-23	2.70 ft - 5.10 ft (0.82 - 1.55 m)	Dual	TLV	50 mm - 115 mm	2.30 lb (1.04 kg)	
5010-00-RED	1.28 ft (0.39 m)	N/A	N/A	N/A	1.50 lb (0.68 kg)	
5010-00-FLY	1.28 ft (0.39 m)	N/A	N/A	N/A	1.50 lb (0.68 kg)	
5010-01	4.7 inches (120 mm)	N/A	N/A	25 mm	0.40 lb (0.02 kg)	
5700-21	2.26 ft - 4.8 ft (0.7 - 1.5 m)	Dual	Quick-Release	50 mm - 115 mm	2.33 lb (1.80 kg)	

### Swiss-Style QLV Prism Poles

QLV Locking Mechanisms



#### FEATURES & BENEFITS

- ▶ Swiss-style quick release stud Reads direct for any 86 mm height prisms
- ▶ The small-diameter, 25 mm bottom section fits Leica slide-on controller brackets
- ▶ QLV™ locking mechanisms
- ▶ Powder-coated and silk screened aluminum
- ▶ Lower lock features a 40-minute vial

Part No.	LENGTH	TIP	Type	GRADS	WEIGHS	
5802-10	8 ft	Swiss-Style	Aluminum	Dual	2.50 lb (1.13 kg)	
5802-20	12 ft	Swiss-Style	Aluminum	Dual	3.55 lb (1.61 kg)	

### Swiss-Style TLV and Twist-Lock Prism Poles

Twist Lock with Vial (TLV)



#### FEATURES & BENEFITS

- ▶ Swiss-style tip (for 86 mm prism heights) for GPH1-type prisms
- ▶ 1.25- or 1.50-inch (31.75- or 38.1-mm) outside diameter
- ▶ Dual or metric graduations TLV™ or Twist-Lock mechanisms
- ▶ Comes in 1 or 3 sections
- ▶ The popular TLV locking system provides simple but secure locking

PART NO.	SECTIONS	LOCK STYLE	LENGTH	OD	GRADS	WEIGHS	
5501-11	1	TLV	8.53 ft - 4.97 ft (2.60 m - 1.51 m)	1.25 inch (31.75 mm)	Dual	3.30 lb (1.50 kg)	
5521-11	1	TLV	2.60 m - 1.51 m	31.75 mm	Metric	3.30 lb (1.50 kg)	
5503-30	3	Twist-Lock	15.25 ft - 5.41 ft (4.65 m - 1.65 m)	1.50 inch (38.1 mm)	Dual	7.60 lb (3.45 kg)	



## Quick-Release Telescopic Prism Poles

Vials are on the locks, out of the way of the instruments on the pole



### FEATURES & BENEFITS

- ▶ Quick-Release locking mechanism with 40-minute vial
- ▶ Adjustable tension via set

- screw in the handle and another set screw to assist in keeping the spring in position
- ▶ Quick-Release handle lock

- allows for a simple and fast setup
- ▶ Constructed of powder-coated and silk screened aluminum

PART NO.	GRADS	SECTIONS	TIP	EXTENDED	COLLAPSED	WEIGHS	
5700-10	Dual	1	Adjustable	8.53 ft (2.60 m)	4.97 ft (1.52 m)	3.30 lb (1.50 kg)	
5720-10	Metric	1	Adjustable	8.53 ft (2.60 m)	4.97 ft (1.52 m)	3.30 lb (1.50 kg)	
5700-20	Dual	2	Adjustable	11.81 ft (3.60 m)	5.18 ft (1.58 m)	5.10 lb (2.30 kg)	

## TLV and Twist-Locking Telescopic Prism Poles

The popular TLV™ locking system provides simple but secure locking



### FEATURES & BENEFITS

- ▶ The aluminum twisting lock with vial (TLV) pole is wear-resistant for long life

- ▶ The soft rubber knob is easy to tighten or loosen, even when wearing gloves
- ▶ TLV locks feature a convenient 40-minute vial built into the lock

- ▶ Made of quality aluminum tubing
- ▶ Powder-coated red and white
- ▶ Vials may be switched out – see page 14 for options

Part No.	SECTIONS	TIP	EXTENDED	COLLAPSED	GRADS	WEIGHS	
5500-11	1	Adjustable	8.53 ft (2.60 m)	4.97 ft (1.52 m)	Dual	3.30 lb (1.50 kg)	
5512-11	1	Fixed	8.53 ft (2.60 m)	4.97 ft (1.52 m)	Dual	3.30 lb (1.50 kg)	
5520-11	1	Adjustable	8.53 ft (2.60 m)	4.97 ft (1.52 m)	Metric	3.30 lb (1.50 kg)	
5500-21	2	Adjustable	11.81 ft (3.60 m)	5.18 ft (1.58 m)	Dual	5.10 lb (2.32 kg)	
5520-21	2	Adjustable	11.81 ft (3.60 m)	5.18 ft (1.58 m)	Metric	5.10 lb (2.32 kg)	
5500-30	3	Adjustable	15.25 ft (4.65 m)	5.41 ft (1.65 m)	Dual	7.60 lb (3.45 kg)	
5520-30	3	Adjustable	15.25 ft (4.65 m)	5.41 ft (1.65 m)	Metric	7.60 lb (3.45 kg)	

## Quick Change Pole Adapters

Use with SECO Quick Change Prism Poles to achieve desired height

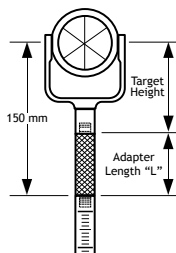

### FEATURES & BENEFITS

- ▶ Using adapters, any of the poles in the Quick Change series can be used for GNSS,

- robotics or total station surveys
- ▶ Quick conversions to another application by changing adapters

- ▶ Simple adapter determinations: 150 mm minus your target height = length of adapter needed

Part No.	Target	Target Height	Length "L"	
2090-10	Leica GPH1	60 mm	90 mm	
2090-11	SECO 6400 Series	100 mm	50 mm	
2090-12	SECO 6400 Series	115 mm	35 mm	
2090-13	Trimble RMT	135 mm	15 mm	
2090-14	Adjustable 5/8 x 11	50 mm to 135 mm	N/A	
2090-15	GNSS Antenna	0 mm	150 mm	
2090-17	Leica Adjustable	86 mm to 125 mm	N/A	
2090-19	SECO Mini Prisms	70 mm	80 mm	
2090-21	Topcon 360 Prism	77 mm	73 mm	
2090-26	Topcon APT1/2	50 mm	100 mm	
5079-066	Laser Detector Adapter	0 mm	150 mm	

### Compression Lock Telescopic Prism Poles

Constructed of brass and aluminum



#### FEATURES & BENEFITS

- ▶ Compression locking mechanism
- ▶ Constructed of sturdy aluminum tubing and a two-stage adjustable top-threaded tip
- ▶ Adjustable Tip
- ▶ Single (1) section pole
- ▶ Extends 8.53 ft (2.60 m)
- ▶ Collapses 4.97 ft (1.516 m)
- ▶ Dual graduations
- ▶ Finished with electrostatic powder paint coating on the outer pole and permanent silkscreened grads on the inner pole
- ▶ Weighs 3.30 lb (1.50 kg)

5600-10 — Compression Prism Pole

### QLV Locking Prism Poles

Simple to adjust bubble and lever tension



QLV lock body   Fixed Tip   Adjustable Tip

#### FEATURES & BENEFITS

- ▶ The QLV™ (Quick Lever with Vial) lock allows fast, simple setups
- ▶ Simple to adjust bubble and lever tension
- ▶ Includes a lock with 40-minute level vial, adjustable, or fixed tip and your choice of dual (10ths) or metric graduations (cm)
- ▶ Easy locking
- ▶ Finished with electrostatic powder paint coating on the outer pole and permanent silkscreened grads on the inner pole

PART NO.	SECTIONS	TIP	Extends	Collapses	GRADS	WEIGHTS	
5801-10	1	Adjustable	8.53 ft (2.60 m)	4.97 ft (1.516 m)	Dual	2.95 lb (1.50 kg)	
5813-10	1	Fixed	8.53 ft (2.60 m)	4.97 ft (1.516 m)	Dual	2.95 lb (1.50 kg)	

### Ultralite Prism Poles

Non-conductive fiberglass



#### FEATURES & BENEFITS

- ▶ The lightest pole offered by SECO
- ▶ Included in this package is Seco's patented Topo Boot®
- ▶ Reduced weight SECO TLV™ lock
- ▶ Features a 40-minute adjustable vial, a soft touch knob, and an adjustable 5/8 x 11 tip
- ▶ The inner and outer poles are constructed of lightweight non-conductive fiberglass
- ▶ Vials may be switched out – see page 14 for options

PART NO.	SECTIONS	TIP	LENGTH	VIAL	GRADS	WEIGHTS	
5540-10	1	Adjustable	8.58 ft (2.62 m)	40-minute	Dual	1.95 lb (0.88 kg)	
5541-10	1	Adjustable	2.62 m (8.58 ft)	40-minute	Metric	1.95 lb (0.88 kg)	
5540-20	2	Adjustable	11.81 ft (3.60 m)	40-minute	Dual	2.50 lb (1.13 kg)	
5541-20	2	Adjustable	3.60 m (11.81 ft)	40-minute	Metric	2.50 lb (1.13 kg)	
5540-30	3	Adjustable	15.27 ft (4.65 m)	40-minute	Dual	3.15 lb (1.43 kg)	
5541-30	3	Adjustable	4.65 m (15.27 ft)	40-minute	Metric	3.15 lb (1.43 kg)	

**Contractor Series  
TLV Prism Poles**

Import TLV™ prism poles



**FEATURES & BENEFITS**

- ▶ These 'no-frills' imported poles are designed to give service in the field at a lower purchase price
- ▶ TLVs and Twist-Locks include 40-minute level vials
- ▶ Aluminum outer and inner pole
- ▶ Hardened steel points
- ▶ Your choice of metric (cm) or dual (cm/10ths) graduations
- ▶ Traditional red and white color

PART NO.	SECTIONS	TIP	LENGTH	POLE TYPE	GRADS	WEIGHS
5530-10	1	Adjustable	8.53 ft (2.60 m)	Aluminum	Dual	2.67 lb (1.21 kg)
5531-10	1	Adjustable	2.60 m	Aluminum	Metric	2.67 lb (1.21 kg)
5530-20	2	Adjustable	11.81 ft (3.60 m)	Aluminum	Dual	3.65 lb (1.66 kg)
5531-20	2	Adjustable	3.60 m	Aluminum	Metric	3.65 lb (1.66 kg)
5530-30	3	Adjustable	15.25 ft (4.65 m)	Aluminum	Dual	5.38 lb (2.44 kg)
5531-30	3	Adjustable	4.65 m	Aluminum	Metric	5.38 lb (2.44 kg)

**Contractor Series  
Compression Lock Poles**

Traditional Compression lock import prism poles



**FEATURES & BENEFITS**

- ▶ These 'no-frills' imported poles are designed to give service in the field at a lower purchase price
- ▶ Your choice of metric (cm) or dual (cm/10ths) graduations
- ▶ Aluminum outer and inner pole
- ▶ 40-minute level vials
- ▶ Adjustable tip
- ▶ Hardened steel points
- ▶ Red and white color

PART NO.	SECTIONS	TIP	LENGTH	POLE TYPE	GRADS	WEIGHS
5631-10	1	Adjustable	2.60 m (8.53 ft)	Aluminum	Metric	2.65 lb (1.20 kg)
5631-20	2	Adjustable	3.60 m (11.81 ft)	Aluminum	Metric	3.45 lb (1.56 kg)
5631-30	3	Adjustable	4.65 m (15.25 ft)	Aluminum	Metric	5.00 lb (2.27 kg)

**Offset Tools**

- ▶ Used with total stations and prism poles to help get accurate elevation measurements in hard-to-reach places such as sewer lines
- ▶ Has an adjustable centerline, 1.60 to 1.00-ft (48.76 to 30.48-cm) in 0.20-ft (6.09-cm) increments
- ▶ Constructed of anodized 1/2 inch thick aluminum
- ▶ Includes brass male 5/8 x 11 threaded post and a stainless steel 5/8 x 11 Heli-Coil®
- ▶ Weighs 1.15 lb (0.52 kg)
- ▶ Maintains Exact Pole Elevation Readings!



5198-163 — Adjustable Offset Bar

- ▶ Perform odd setups and stay away from dangerous situations with the Offset Pole Holder Kit
- ▶ Combine the kit with any 5/8 x 11 threaded pole and a Heads-Up™ Level (PN 5001-20, page 14) for a safe and sturdy setup
- ▶ A padded case, hex wrench, and an adapter plate for instrument tripods is included
- ▶ Weighs 1.79 lb (0.81 kg)



5198-157 — Offset Pole Holder Kit

### Prism Adapters, Tips and Topo Shoes

- ▶ Adapts Swiss-style snap-on prisms to 5/8 x 11 tribrach adapter or prism pole
- ▶ Weighs 0.06 lb (0.03 kg)



**2080-SS — Wild Prism Adapter**   
**2080-00 — Wild Prism Adapter** 

- ▶ 5/8 x 11 Female to 1/4 x 20 Female Adapter
- ▶ 5/8 x 11 Male to 1/4 x 20 Male Adapter
- ▶ Weighs 0.20 lb (0.09 kg)



**2131-00 — Prism Pole Adapter - Male**   
**2131-01 — Prism Pole Adapter - Female** 

- ▶ 5/8 x 11 adapter
- ▶ Weighs 0.06 lb (0.03 kg)



**5180-00 — Double Male Adapter** 

- ▶ 5/8 x 11 Double Female Adapter
- ▶ Weighs 0.08 lb (0.04 kg)



**5181-00 — Double Female Adapter** 

- ▶ The Delrin® Adapter can be used when you want to increase the outside diameter (OD) of a pole from 1-inch to 1.25-inches or if you have a 1 inch OD pole and want to use a Claw™ pole clamp
- ▶ Can be used with Quick-Release Claw Cradles and Clamps or the Ball-and-Socket Claw Combo
- ▶ Weighs 0.03 lb (0.01 kg)



**D11145 — Delrin 1-inch Pole Claw Clamp Adapter** 

- ▶ 3.37-inch (85.6-mm) steel body
- ▶ Weighs 0.30 lb (0.14 kg)



**5190-00 — Prism Pole Point** 

- ▶ 3.37-inch (85.6-mm) steel body, removable point
- ▶ Weighs 0.30 lb (0.14 kg)



**5194-00 — Prism Pole Point with Replaceable Plumb Bob Point** 

- ▶ 3.37-inch (85.6-mm) aluminum body
- ▶ Removable point
- ▶ Weighs 0.10 lb (0.05 kg)



**5194-01 — Aluminum Replaceable Point** 

- ▶ 3.37-inch (85.6-mm) aluminum with steel tip (91605)
- ▶ Weighs 0.01 lb (0.004 kg)
- ▶ The topo-shoe (91601) screws over the precision point made of black nylon and increases the area of the point for the use on soft surfaces in topo shots
- ▶ Weighs 0.05 lb (0.02 kg)



**91605 — Aluminum Prism Pole Point and Steel Tip**   
**91601 — Topo Shoe** 

- ▶ This prism allows for easy determination of right angle points or perpendicular points between two targets



**4900-00 — Double Right-Angle Prism** 

- ▶ 3.37-inch (85.6-mm) anodized aluminum body, dull or steel point
- ▶ Weighs 0.16 lb (0.07 kg)



**5194-03 — Lightweight Prism Pole Point with Replaceable Steel Point Tip**   
**5194-007 — Lightweight Prism Pole Point with Replaceable Dull Point Tip** 

- ▶ Hardened steel replacement point for 5194-series
- ▶ Weighs 0.06 lb (0.03 kg)



**5194-003 — Prism Pole Sharp Point** 

- ▶ This point features an anodized aluminum body and an easy-to-replace steel point
- ▶ Weighs 0.16 lb (0.07 kg)



**5194-05 — Prism Pole Point, Sharp** 

- ▶ Features an 'L-Bracket' to rest the prism pole point on and the adjustable top piece
- ▶ Convenient for adjusting and calibrating pole vials in the office
- ▶ Use the adjustable top to center your pole before adjusting the bubble
- ▶ Weighs 1.00 lb (0.45 kg)



**5195-01 — Pole Peg Adjusting Jig** 

- ▶ Stedi-Rest® fits any 1.25 to 1.5 inch (31.75 to 38.1-mm) pole and can take the place of three separate products
- ▶ Weighs 0.15 lb (0.07 kg)



**91641 — Stedi-Rest®** 

- ▶ The Center Punch Point fits all poles or products with male 5/8 x 11 threads
- ▶ The hardened steel point will mark all metal and non-metal surfaces
- ▶ Weighs 0.20 lb (0.09 kg)



**5194-10 — Center Punch Point**   
**5194-10-002 — Replacement Point** 

- ▶ The point features an aluminum body and an easy-to-replace steel point
- ▶ Male 5/8 x 11 Thread
- ▶ Weighs 0.16 lb (0.07 kg)



**5194-04 — Point Assembly** 

- ▶ 3.37-inch (85.6-mm) aluminum body
- ▶ Weighs 0.34 lb (0.15 kg)



**5191-00 — Prism Pole Topo Shoe** 

- ▶ 3.37-inch (85.6-mm) length
- ▶ 64 mm OD with steel body
- ▶ Weighs 1.26 lb (0.57 kg)



**5192-00 — Wide Base Topo Shoe** 

- ▶ Allows easy conversions from 'control' to 'topo' surveys



**5192-02 — Topo Shoe and Point Combo** 

- ▶ 2-inch (50.8-mm) diameter chrome-plated steel housing with grade-8 ceramic magnet ring
- ▶ Standard topo shoe length, 3.375-inch (85.7-mm)
- ▶ Magnet has 40 pounds of pull force on 3/8-inch (9.5-mm) clean steel plate
- ▶ Female 5/8 x 11 threads are machined brass
- ▶ Black anodized aluminum alloy 6061 body
- ▶ Tilting pivot allows measurement on sloped or flat pipe surfaces
- ▶ Weighs 0.55 lb (0.25 kg)



**5193-04 — Tilting Magnetic Topo Shoe** 



**Range Pole Accessories**

- ▶ The Rodrest is a self-retracting 'kickstand' for survey rods
- ▶ Activated by simply pushing down a few inches on the handle
- ▶ Weighs 1.55 lb (0.70 kg)

Pole not included.



5214-01 — Gardener Rod Rest 1.25-inch OD

- ▶ Quickly connect this new accessory to your Rover Rod
- ▶ Holds the Rod upright when you need to "park"
- ▶ Makes moving from point to point easy, fast and tireless
- ▶ Six-inch diameter solid wheels, travels over hard and rough surfaces
- ▶ Folds for easy storage when not in use
- ▶ Legs made of anodized aluminum bar
- ▶ Weight 3.1 lbs (1.4 kg)
- ▶ Reduce your daily effort with this new product designed to save energy and effort in the field

Pole and Bipod not included.

5125-058 — Pole Transporter



Shown parked and balanced

**Pole Extensions**

Aluminum, carbon fiber or fiberglass extensions

**FEATURES & BENEFITS**

- ▶ The pole extensions have 5/8 x 11 female threads on

the bottom and 5/8 x 11 male threads on the top to allow more added sections

- ▶ Choose powder-painted aluminum, carbon fiber, or fiberglass



Part No.	OUTSIDE DIAMETER	LENGTH	POLE TYPE	WEIGHTS	
5182-001	1 in (25 mm)	3 in (7.62 cm)	Aluminum	0.40 lb (0.18 kg)	
5132-00-ACL	1 in (25 mm)	6 in (15.2 cm)	Aluminum	0.50 lb (0.23 kg)	
5130-01-FLY	1 in (25 mm)	1 ft (30.5 cm)	Aluminum	1.00 lb (0.45 kg)	
5902-00-FLY	1 in (25 mm)	50 cm (19.69 in)	Aluminum	0.70 lb (0.32 kg)	
5131-01-FLY	1 in (25 mm)	2 ft (61 cm)	Aluminum	1.10 lb (0.50 kg)	
5901-00-FLY	1 in (25 mm)	1 meter (39.37 in)	Aluminum	1.10 lb (0.50 kg)	
5110-01-FLY	1 in (25 mm)	4 ft (1.22 m)	Aluminum	1.30 lb (0.59 kg)	
5145-00-FLY	1.25 in (32 mm)	25 cm (9.84 in)	Aluminum	0.90 lb (0.41 kg)	
5130-00-FLY	1.25 in (32 mm)	1 ft (30.5 cm)	Aluminum	1.00 lb (0.45 kg)	
5144-00-FLY	1.25 in (32 mm)	50 cm (19.69 in)	Aluminum	1.00 lb (0.45 kg)	
5131-00-YEL	1.25 in (32 mm)	2 ft (61 cm)	Aluminum	1.10 lb (0.50 kg)	
5143-00-FLY	1.25 in (32 mm)	1 meter (39.37 in)	Aluminum	1.30 lb (0.59 kg)	
5110-00-FLY	1.25 in (32 mm)	4 ft (1.22 m)	Aluminum	1.30 lb (0.59 kg)	
5110-00-RED	1.25 in (32 mm)	4 ft (1.22 m)	Aluminum	1.30 lb (0.59 kg)	
5145-03	1 in (25 mm)	25 cm (9.84 in)	Carbon Fiber	0.35 lb (0.16 kg)	
5145-02	1.25 in (32 mm)	25 cm (9.84 in)	Carbon Fiber	0.35 lb (0.16 kg)	
5144-02	1.25 in (32 mm)	50 cm (19.69 in)	Carbon Fiber	0.50 lb (0.23 kg)	
5143-02	1.25 in (32 mm)	1 meter (39.37 in)	Carbon Fiber	0.70 lb (0.32 kg)	
5130-10	1.25 in (32 mm)	0.20 meter (7.87 in)	Fiberglass	0.34 lb (0.15 kg)	

**Imported Range Poles**

Contractor Series of Extendible Section Poles

- ▶ Single 4-foot (1.22-m) section range pole
- ▶ 1.13-in (29-mm) outside diameter
- ▶ With brass male/female fittings on all range poles
- ▶ Includes bag (no point included)
- ▶ Weighs 1.50 lb (0.68 kg)



5160-02-WOR — Contractor Series 4-ft Range Pole

- ▶ Two 4-ft (1.22 m) sections creating 8-ft (2.44-m) range pole
- ▶ 1.13-in (29-mm) outside diameter
- ▶ With brass male/female fittings on all range poles
- ▶ Includes point and bag
- ▶ Weighs 3.40 lb (1.54 kg)



5140-02-WOR — Contractor Series 8-ft Range Pole

- ▶ Three 4-foot (1.22-m) sections creating 12-ft (3.66-m) range pole
- ▶ 1.13-in (29-mm) outside diameter
- ▶ With brass male/female fittings on all range poles
- ▶ Includes point and bag
- ▶ Weighs 5.00 lb (2.27 kg)



5150-02-WOR — Contractor Series 12-ft Range Pole

### Prism Pole Bipods & Tripods

#### Prism Pole Bipods And Tripods

- ▶ A surveyor can set up a free-standing GNSS antenna pole or prism pole
- ▶ Poles 1- to 1.25-inch (25.6- to 32-mm) OD attach through the open clamp
- ▶ 1.5-inch (38.1 mm) OD poles can be loaded through the top
- ▶ Legs (independently) extend to 6 feet (1.8 m)
- ▶ Collapses to 43 inches (109 cm)
- ▶ Weighs 4.25 lb (1.93 kg)
- ▶ Order bag 8180-20 and leg clips 5217-30

★ Includes No-Crush Head



- 5217-04-FOR — Original Thumb Release Bipod
- 5217-04-FLY — Original Thumb Release Bipod
- 5217-04-RED — Original Thumb Release Bipod
- 5217-04-YEL — Original Thumb Release Bipod

- ▶ A surveyor can set up a free-standing GNSS antenna pole or prism pole
- ▶ Poles 1- to 1.25-inch (25.6- to 32-mm) OD attach through the open clamp
- ▶ 1.5-inch (38.1 mm) OD poles can be loaded through the top
- ▶ Legs (independently) extend to 6 feet (1.8 m)
- ▶ Collapses to 43 inches (109 cm)
- ▶ Weighs 4.25 lb (1.93 kg)
- ▶ Comes with bag and leg clips for easy transportation

★ Includes No-Crush Head



- 5217-40-FLY — Thumb Release Bipod
- 5217-40-RED — Thumb Release Bipod
- 5217-40-YEL — Thumb Release Bipod

- ▶ This assembly easily converts your existing prism/range pole bipod to a prism/range pole tripod when extra stability is needed!
- ▶ Easy to attach or remove with our "open clamp" design
- ▶ Operation is exactly the same as a one-piece Pole Tripod
- ▶ Same construction as the third leg on a Pole Tripod
- ▶ A good accessory for 5217-04 and 5217-40
- ▶ Weighs 1.85 lbs (0.84 kg)



- 5218-06-FLY — Solo Leg with Clamp
- 5218-06-FOR — Solo Leg with Clamp
- 5218-06-RED — Solo Leg with Clamp
- 5218-06-YEL — Solo Leg with Clamp

- ▶ Carbon Fiber Thumb Release Bipod uses the same design concepts as the SECO aluminum Thumb Release Bipod, but weighs less
- ▶ 1- to 1.25-inch (25.6- to 32-mm) diameter poles attach easily through the open clamp
- ▶ 1.5-inch (38.1-mm) OD poles can be loaded through the top
- ▶ Collapses to 43-inches (109-cm)
- ▶ Legs (independently) extend to 6-feet (1.8-m)
- ▶ Weighs 4.10 lb (1.86 kg)

★ Includes No-Crush Head



- 5219-03 — Carbon Fiber Thumb Release Bipod

- ▶ The Carbon Fiber Thumb Release Tripod features a large 5-lobe soft touch rubber clamping knob, and legs of super strong, lightweight carbon fiber
- ▶ Legs collapses to 43-inches (109-cm)
- ▶ Legs extend to 6-ft (1.8-m)
- ▶ Weighs 4.10 lb (1.86 kg)



- 5219-05 — Carbon Fiber Thumb Release Tripod

- ▶ To upgrade older bipod models, use this upgrade kit
- ▶ Contoured head design prevents crushing of carbon fiber range or prism poles even when excess force is used
- ▶ All metal design is "form fitting" for all popular pole sizes.
- ▶ Weighs 4.25 lb (1.93 kg)



- 5217-072 — Upgrade kit, for any existing SECO bipod to the new head design

**Bipods & Tripods**

- ▶ This tripod is ideal for use with poles under 24-inches (61-cm) long 1- to 1.5inch (25.4- to 38.1-mm) diameter poles thread easily through the open clamp on top
- ▶ Legs are fixed at 12-inches (30.5-cm) each
- ▶ Includes stainless steel clamp screw and rubber tips
- ▶ Rod, 5010-00-RED, page 18, not included
- ▶ Weighs 1.30 lb (0.60 kg)



5218-15-ABK — Mini Tripod with 12 inch Legs

- ▶ The Mini Bipod utilizes the same design concepts as the popular 5217-04 bipod, just shorter (see below)
- ▶ Poles 1- to 1.25-inch (25.6- to 32-mm) diameter attach easily through the open clamp
- ▶ Poles 1.5-inch (38.1-mm) OD can load through the top
- ▶ Collapses to 25 inches (63.5 cm)
- ▶ Extends to 35 inches (88.9 cm)
- ▶ Leg clip is included (5217-30)
- ▶ Weighs 3.50 lb (1.60 kg)



★ Includes No-Crush Head

- 5217-05-FOR — Thumb Release Mini Bipod
- 5217-05-FLY — Thumb Release Mini Bipod
- 5217-05-RED — Thumb Release Mini Bipod
- 5217-05-YEL — Thumb Release Mini Bipod

- ▶ The tripod features a ball-and-socket head, which makes leveling a bubble easy
- ▶ Legs extend from 2.62- to 4.17-ft (80-cm to 1.3-m)
- ▶ The rubberized jaws hold a pole (up to 2-inch (51-mm) OD) firmly in place
- ▶ Carrying case is included
- ▶ Weighs 2.65 lb (1.20 kg)



Alligator clamp with rubberized jaws!

5214-00 — Alligator Clamp Prism Pole Tripod

- ▶ The bipod leg clip easily attaches to the base of any 1.25-inch (32-mm) OD prism or antenna pole
- ▶ The bipod legs snap into the clip making the system convenient for transport or storage
- ▶ Ideal for 5217-04 series
- ▶ Can be used for prism pole tripods with combination of 2 units
- ▶ Weighs 0.04 lb (0.02 kg)



5217-30 — Bipod Leg Clip

- ▶ SECO manufactured, not imported
- ▶ Thumb-Release™ Tripods creates free-standing GNSS antenna poles or prism poles
- ▶ The thumb lock design allows adjustment of tension without disassembly of the leg
- ▶ Universal head accommodates poles from 1- to 1.5-inch (25.6- to 38.1-mm) OD
- ▶ Legs extend (independently) to 6-ft (1.8-m)
- ▶ Feature large, smooth, thumb release buttons
- ▶ Constructed of powder-coated aluminum
- ▶ Weighs 6.00 lb (2.60 kg)



- 5218-02-FLY — Original Thumb Release Tripod
- 5218-02-FOR — Original Thumb Release Tripod
- 5218-02-RED — Original Thumb Release Tripod
- 5218-02-YEL — Original Thumb Release Tripod

- ▶ Thumb-Release™ Tripods creates free-standing GNSS antenna poles or prism poles
- ▶ The thumb lock design allows adjustment of tension without disassembly of the leg
- ▶ Universal head accommodates poles from 1- to 1.5-inch (25.6- to 38.1-mm) OD
- ▶ Legs extend (independently) to 6-ft (1.8-m)
- ▶ Feature large, smooth, thumb release buttons
- ▶ Constructed of powder-coated aluminum
- ▶ Weighs 6.00 lb (2.60 kg)



- 5218-40-FLY — Thumb Release Tripod
- 5218-40-RED — Thumb Release Tripod
- 5218-40-YEL — Thumb Release Tripod

# PRISM basics

### Prism Offsets

- ▶ Corner cube prisms (or retroreflectors) used with electronic distance measuring (EDM) instruments have an offset due to the fact that the transmitted light beam from the EDM takes longer to enter and exit the prism. This longer time translates to a longer distance measured. This distance is corrected by using an 'offset' and/ or positioning the prism in relationship to the plumb line of the prism holder. The offset is determined by multiplying the height of the prism by the refractive index of the glass used. Common offsets are 0, -17.5 mm, -30 mm, -34 mm, and -40 mm.

### Nodal Offsets

- ▶ A nodal offset is defined by the relationship of the prism holder and prism that places the optical center of the prism on the plumb line of the holder. This offset is the most advantageous at close range work when the apex or center of the prism is used as a pointing target for vertical and horizontal angle measurement. Every prism has a nodal offset. Prisms and holders that are not in the nodal position however, can cause angular errors when using the prism apex as a target if it is not perfectly pointed toward the measuring instrument.
- ▶ To reduce pointing errors, several SECO prism assemblies are designed with a nodal point alignment at -17.5 (for 25 mm prisms) or -40 mm offset (for 62 mm prisms). See illustration at right.
- ▶ Commonly, the best reading of the beam is achieved when the prism face is perpendicular to the incoming beam for a parallel return. Unfortunately, ideal alignment is not always achieved in the field.
- ▶ To compensate for pointing errors, nodal point alignment minimizes the error associated with misalignments (two illustrations below).

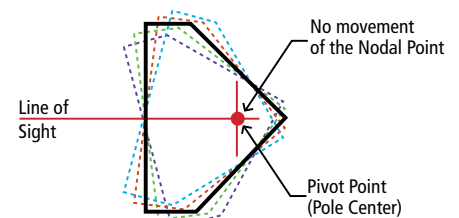

at -17.5 or -40 mm Offset

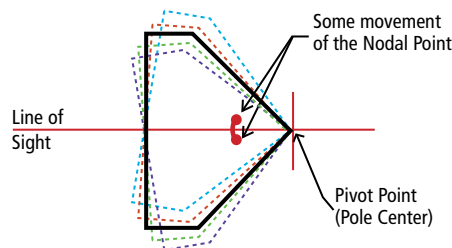

Non-Aligned at -30 mm Offset

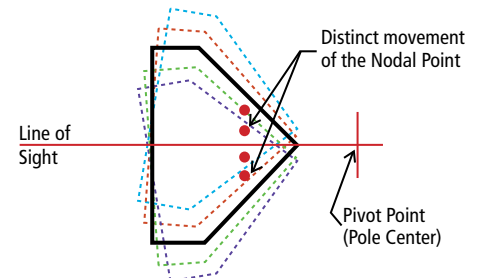

Non-Aligned at 0 mm Offset

### Prism Range

- ▶ Corner cube prisms redirect the measuring beam back to the EDM for signal processing.
- ▶ There are two main factors for good range measurement: prism diameter and beam deviation.
- ▶ If the beam deviation is not accurate enough, the returned beam will miss the EDM entirely.
- ▶ This occurs mainly near the maximum range of the EDM (check with your manufacturer).
- ▶ SECO standard prisms are <5 seconds. Higher accuracy prisms are also available.

### Prism Holder Accuracy

- ▶ Prism accuracy is determined by the physical location of the prism in its canister and then to its holder. SECO prism accuracy is 1 mm or less.



**Premier Prism Assemblies Copper**

62 mm Rear Screw Lock



**FEATURES & BENEFITS**

- ▶ Tilting holder is anodized aluminum and features a
- ▶ 62 mm copper-coated canister prism
- ▶ Features an improved brass locking thumb screw design and a light but durable metal holder
- ▶ Tilting axis height is 115 mm
- ▶ Mounted in either 0 or
- ▶ -30 mm offset positions

PART NO.	TARGET COLOR	TARGET SIZE	Weights	
6402-02-FLB	Flo Yellow with Black	6 x 9 in	1.75 lb (0.79 kg)	
6402-02-FOB	Flo Orange with Black	6 x 9 in	1.75 lb (0.79 kg)	
6402-02-YLB	Yellow with Black	6 x 9 in	1.75 lb (0.79 kg)	
6422-02-FOB	Flo Orange with Black	5.5 x 7 in	1.59 lb (0.72 kg)	
6422-02-YLB	Yellow with Black	5.5 x 7 in	1.59 lb (0.72 kg)	

**Premier Prism Assemblies Silver**

62 mm Rear Lever Lock



**FEATURES & BENEFITS**

- ▶ The heavy-duty 62 mm silver-coated prism is sealed in a strong canister with an o-ring to prevent water and dust from getting inside
- ▶ Incorporates a simple rear-locking stainless steel lever mechanism that is easy to set while adjusting the prism and target tilt
- ▶ Prism can be mounted in either 0 or -30 mm offset positions
- ▶ 115 mm tilting axis height
- ▶ Two target sizes and three color combinations are available

PART NO.	TARGET COLOR	TARGET SIZE	Weights	
6402-20-FLB	Flo Yellow with Black	6 x 9 in	1.75 lb (0.79 kg)	
6402-20-FOB	Flo Orange with Black	6 x 9 in	1.75 lb (0.79 kg)	
6402-20-YLB	Yellow with Black	6 x 9 in	1.75 lb (0.79 kg)	
6422-20-YLB	Yellow with Black	5.5 x 7 in	1.59 lb (0.72 kg)	

**Prism Premier Assemblies Strobe**

62 mm blinking strobe prism assembly



**FEATURES & BENEFITS**

- ▶ Combines the premier target and holder with a strobe prism
- ▶ Features a blinking strobe prism with an LED light that flashes every 0.5-second
- ▶ This prism can be purchased separately (6416-00, page 36)
- ▶ Perfect for low light conditions
- ▶ Tilting axis height is 115 mm
- ▶ Weighs 1.35 lb (0.62 kg)

PART NO.	TARGET COLOR	TARGET SIZE	
6402-03-FLB	Flo Yellow with Black	6 x 9 in	
6402-03-FOB	Flo Orange with Black	6 x 9 in	
6402-03-YLB	Yellow with Black	6 x 9 in	

### Premier Prism Assemblies

-35 mm to work with Trimble and Zeiss Total Stations



#### FEATURES & BENEFITS

- ▶ Features a -35 mm offset and a prism accuracy of <5 seconds
- ▶ Mounting base features standard female 5/8 x 11 threads
- ▶ Tilting holder is constructed of anodized aluminum
- ▶ Height of the prism in the holder is 135 mm
- ▶ 62 mm silver-coated prism is encased in a heavy-duty canister with M20 threads
- ▶ Weighs 1.75 lb (0.80 kg)
- ▶ Nodal

Part No.	TARGET COLOR	TARGET SIZE
6402-05-FOB	Flo Orange with Black	6 x 9 in
6402-05-YLB (shown)	Yellow with Black	6 x 9 in

### Premier Prism Assemblies

-30 and 0 mm to work with Nikon, Topcon & Sokkia Total Stations



#### FEATURES & BENEFITS

- ▶ 62 mm copper-coated prism is encased in a heavy-duty canister with M20 threads
- ▶ Features a -30 and 0 mm offset
- ▶ Height of the prism in the holder is 100 mm
- ▶ Tilting holder is constructed of anodized aluminum
- ▶ Prism accuracy of <5 seconds
- ▶ Mounting base features standard female 5/8 x 11 threads
- ▶ Weighs 1.75 lb (0.80 kg)

Part No.	TARGET COLOR	TARGET SIZE
6402-06-FLB	Flo Yellow with Black	6 x 9 in
6402-06-FOB	Flo Orange with Black	6 x 9 in
6402-06-YLB (shown)	Yellow with Black	6 x 9 in

### Standard Prism Assembly

Contractor Series 62 mm prism assembly



#### FEATURES & BENEFITS

- ▶ Features a 62 mm copper-coated canister type prism
- ▶ Water-resistant and has a M20 universal mounting thread
- ▶ Tilting holder is powder-painted die cast aluminum
- ▶ Uses a simple but proven locking system
- ▶ Target size 5.5" x 7"
- ▶ Mounted in either 0 or -30 mm offset positions
- ▶ Tilting axis height is 115 mm
- ▶ Weighs 1.35 lb (0.62 kg)

- 6402-10-FOB — Prism Assembly in Flo Orange with Black
- 6402-10-FLB — Prism Assembly in Flo Yellow with Black
- 6402-10-YLB — Prism Assembly in Yellow with Black



Swiss Style Surveying Prism Assembly



Long Range Target

**FEATURES & BENEFITS**

- ▶ This high-quality GPH1 Swiss-style prism assembly features a copper coated prism for consistent results and a removable target
- ▶ Metal prism holder
- ▶ Reversible target (long and short range, long range shown)
- ▶ Coating: Copper High Reflex coating and anti-reflex on front
- ▶ Offset: -34 mm, Nodal
- ▶ Diameter: 64.9 mm
- ▶ Centring accuracy: 1 mm
- ▶ Carrying case included
- ▶ Height: 86 mm
- ▶ Weighs 1.32 lb (0.60 kg)

GEOPRISM — Surveying Prism with Metal Housing

**Prism Assembly: Tilting Single**

Swiss Style Prism Assembly



**FEATURES & BENEFITS**

- ▶ Includes copper-coated 62 mm prism (6411-02)
- ▶ -30 mm offset aluminum prism holder, sealed with a rugged corrosion-proof electrostatic powder paint coating
- ▶ Target Size: 4.75" x 4.75"
- ▶ 115 mm prism height
- ▶ Weighs 1.50 lb (0.68 kg)

6440-00-FOR — Single Prism Tilting Assembly

**Prism Assembly: Nodal Point**

-34 Swiss Style Prism Assembly



**FEATURES & BENEFITS**

- ▶ -34 mm offset prism
- ▶ Quick Release
- ▶ 62 mm diameter copper coated prism
- ▶ 86 mm Height
- ▶ Weighs 0.92 lb (0.42 kg)

6406-00 — Nodal Point 62 mm Prism Assembly

### Prism: Sliding, Tilt Reflector

Use with Prism Pole or Site Rod



#### FEATURES & BENEFITS

- ▶ Attaches to the bottom of the graduated section of a pole so heights can be taken close to the ground
- ▶ Includes a large, 2.5 inch (63.5 mm) silver-coated prism with protective rubber ring
- ▶ 0 offset and 40-min leveling vial
- ▶ Tilts in 15° increments, spring locked
- ▶ Large easy-to-use clamping knob

- ▶ Targets made of fluorescent-yellow translucent polycarbonate
- ▶ Use with prism pole or site rod
- ▶ Weighs 0.81 lb (0.37 kg)

6455-00 — Sliding Prism with Tilting Reflector 

### Prism Assembly: Tilting Triple

Complete system is perfect for longer distances

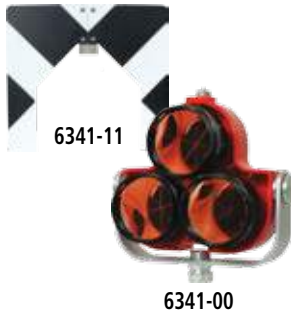

#### FEATURES & BENEFITS

- ▶ Made from orange polycarbonate with metal inserts and an aluminum yoke
- ▶ Holds one to three prisms, is compatible with most screw-in prisms
- ▶ Has a peep sight for pointing the holder, perfect for longer distances

- ▶ Includes three sealed copper-coated 62 mm prisms in black canisters (6411-02-BLK)
- ▶ 0 and -30 mm prism offset
- ▶ Weighs 2.70 lb (1.23 kg)

6341-00 — Tilting Triple Prism Assembly   
6341-11 — Tilting Triple Prism Target 

### Prism Assembly: Nodal Point

62 mm can be offset to -40 mm



#### FEATURES & BENEFITS

- ▶ The import assembly features a polycarbonate holder, three prism offset positions, 0, -30 and -40 (nodal)
- ▶ The 62 mm prism is silver-coated and has a <5-second accuracy
- ▶ The height to center of glass: 0.33 ft (100 mm)

- ▶ The reversible non-tilting metal target comes in orange & white and black & white
- ▶ Weighs 1.45 lb (0.66 kg)

6400-10 — Nodal Point 62 mm Prism Assembly 

### Prism Assembly: Nodal Point

Eclipse 62 mm can be offset to -40 mm or -30 mm



#### FEATURES & BENEFITS

- ▶ The Eclipse™ prism assembly features a water-resistant, nitrogen-charged, 62 mm target (yellow and black on the reverse)
- ▶ Can be set at a -40 mm, which offers optimal angle measurements, even when tilting in either the horizontal or the vertical axis

- ▶ Height to center of glass: 0.38 ft (115 mm)
- ▶ -30 mm adapter is included
- ▶ Weighs 1.15 lb (0.52 kg)

6400-00 — Eclipse 62 mm Nodal Point Prism Assembly   
6410-00 — -30, -40 Offset Eclipse Prism Holder   
6410-018 — 0 Offset Adapter for Eclipse Prism Assembly 



**Prisms: Mini and Stakeout**



- ▶ Here's a versatile prism system in a small package
- ▶ Assembly features a 25 mm copper-coated prism, for fog prevention, a tilting holder, with friction axis, 0 or -30 mm offset. Can be mounted on a prism pole or tribrach at three heights: 70 mm, 100 mm, 115 mm, or can be hand-held using the plumb bob bracket or with S-hook for quick attachment to plumb bob
- ▶ Includes a 40-minute adjustable circular center or side mounted vial
- ▶ Also included a point for stake-out work, and a system bag with belt loop
- ▶ Powder painted flo orange
- ▶ Weighs 0.34 lb (0.15 kg)



- ▶ The Mini Prism Mono Pod Kit forms a stable base with your 6000-Series Mini Prism
- ▶ Prism not included – sold separately, 6405-10-FOR
- ▶ Kit is easy to set up and can be used by just one person
- ▶ Ideal for: construction surveys, inspections, as built, and many other applications
- ▶ Add a standard 5/8 x 11 extension to the kit to achieve heights to four feet
- ▶ Weighs 2.25 lb (1.02 kg)



5216-00 — Mini Prism Mono Pod Kit 

6200-10-FOR — Mini Prism System with Center Vial   
6200-11-FOR — Mini Prism System with Side Vial (shown) 

- ▶ The Mini Stakeout Prism features a 25 mm, copper-coated prism, aluminum double yoke construction with tilting coaxial target
- ▶ Two on-board 130-minute vials — top and bottom
- ▶ Includes replaceable plumb bob point
- ▶ 0 and -30 mm offset
- ▶ Includes carrying case
- ▶ Weighs 0.62 lb (0.28 kg)



- ▶ The 25 mm Stakeout Prism Assembly features 'site cones' that improve vertical angle pointing — the site cones double as tilting-axis lock knobs
- ▶ Adjustable 40-min vial is mounted on the front side and is easy to see and simple to adjust
- ▶ This mini prism is a zero-offset if you reverse the prism
- ▶ Assembly features a 25 mm copper-coated prism, for fog prevention, a tilting holder, with friction axis, 0 or -30 mm offset. Can be mounted on a prism pole or tribrach at three heights: 70 mm, 100 mm, 115 mm, or can be hand-held using the plumb bob bracket or with S-hook for quick attachment to plumb bob
- ▶ Prism height 50 mm to female 5/8
- ▶ Prism height 100mm to Point
- ▶ Includes carrying case
- ▶ Weighs 0.30 lb (0.14 kg)



6405-01-FOR — 25 mm Stakeout Prism Assembly – Flo Orange   
6405-01-FLY — 25 mm Stakeout Prism Assembly – Flo Yellow 

6405-10-FOR — 25 mm Stakeout Prism Assembly 



- ▶ The white site cones on X and Y axis of the assembly help improve centering of your instrument's crosshairs for vertical and horizontal pointing
- ▶ Used in four height configurations: 50 mm, 100 mm, 115 mm and 150 mm, top or bottom of the pole, handheld, or tribrach mounted
- ▶ Choose between 0/-30 mm or -17.5 mm (nodal) offsets
- ▶ Weighs 0.80 lb (0.36 kg), 1.30 lb (0.59 kg) with heavy-duty point



6405-11-FLY

- ▶ The 25 mm Stakeout Prism Assembly features 'site cones' that improve vertical angle pointing — the site cones double as tilting-axis lock knobs
- ▶ Adjustable 40-min vial is mounted on the front side and is easy to see and simple to adjust
- ▶ -17.5 mm (nodal) offset
- ▶ Includes carrying case
- ▶ Weighs 0.30 lb (0.14 kg)



6405-11-FOR — Stakeout Mini Prism Kit - 0 / -30 mm offset – Flo Orange   
6405-11-FLY — Stakeout Mini Prism Kit - 0 / -30 mm offset – Flo Yellow   
6405-13-FLY — Stakeout Mini Prism Kit – Nodal -17.5 mm offset 

6405-12-FOR — 25 mm Stakeout Prism Assembly 

### Prism System: Tilting Mini



#### FEATURES & BENEFITS

- ▶ The Eclipse™ mini system includes: a Mini Tilting Prism;

plumb bob attachment; Mini Bob Prism Mount; Point, and Belt Case

- ▶ 0 and -30 offsets
- ▶ Black hardware
- ▶ Case included
- ▶ Weighs 0.30 lb (0.14 kg)

6450-00-BLK — Tilting Mini Prism System 

### Prisms: Sliding and Pin Pole Kits



Site cones double as locks

- ▶ This Euro-Style Pole System features a 40-minute adjustable vial, white sight cones and a 5/8 x 11 adapter for standard prism poles (for height of 115 mm)
- ▶ All 30 cm sections are anodized aluminum
- ▶ A carrying case is also included
- ▶ Weighs 1.60 lb (0.73 kg)



- ▶ The sliding 360° Prism Kit allows for quick shots in confined line-of-sight situations and allows for more precise height measurements. Easily find the right shot at the right height!
- ▶ The included adapter allows for easy connection to controllers, making it great for handheld use. Use one or all four pin pole sections for the height/portability you need.
- ▶ The prism assembly slides on 9-mm-diameter solid steel pin poles, graduated in cm
- ▶ The four solid yellow pole sections have cm grooves that the ball-detent in the prism assembly will automatically center on
- ▶ Replaceable stainless steel point
- ▶ The assembly is composed of seven 12.7- mm diameter silver-coated mini-prisms in a 360° configuration
- ▶ Prism offset is +2mm
- ▶ Adjustable circular vial is 40-minute
- ▶ Clamp screw locks the prism assembly anywhere on the pole
- ▶ Data collector adapter and carrying case are included
- ▶ Weighs 1.70 lbs (0.77 kg)





Part No.	Offset	
5910-01-ARD	0 / -30 offset	
5910-02-ARD	-17.5 offset (Nodal)	

5910-24 — Sliding 360° Prism Kit 

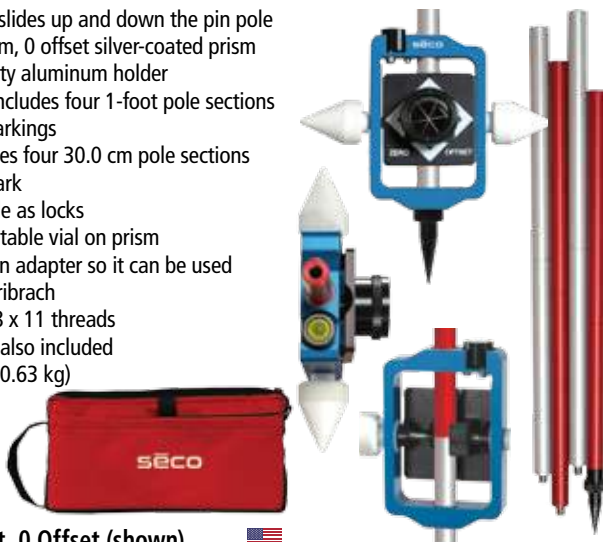
- ▶ Prism assembly slides up and down the pin pole
- ▶ Features a 25 mm, 0 offset silver-coated prism and a high quality aluminum holder
- ▶ Foot kit model includes four 1-foot pole sections with 1/2 foot markings
- ▶ Metric kit includes four 30.0 cm pole sections with a 15 cm mark
- ▶ Site cones double as locks
- ▶ 40-minute adjustable vial on prism
- ▶ Prism includes an adapter so it can be used on any pole or tribrach adapter with 5/8 x 11 threads
- ▶ A system bag is also included
- ▶ Weighs 1.40 lb (0.63 kg)



5910-05 — Feet, 0 Offset (shown)   
5910-06 — Metric, 0 offset 

- ▶ The 12.2 mm OD pin pole features three sections - each 60 cm in length to achieve 5.91 ft (1.8 m); each color section (red or white) is 10 cm in length
- ▶ An adjustable 40-minute circular vial is built in to the prism holder
- ▶ 25 mm sliding prism system features a silver-coated prism with a 0 offset
- ▶ The holder easily slides up and down the pole, the knobs lock in height and tilt – they also double as vertical angle targets
- ▶ Other features include a replaceable stainless steel point on the pole, accessory kit with plumb bob hook and cone for attachment to the prism for handheld applications
- ▶ System Bag included
- ▶ Weighs 1.95 lb (0.90 kg)



6600-10 — Pin Pole with Sliding 25 mm Prism System 

Walleye Prism System



FEATURES & BENEFITS

- ▶ Lightweight and inexpensive, made to be set up and left for extended periods
- ▶ Features & Benefits
- ▶ The Walleye™ Prism System accommodates a full size 62 mm prism (6411-03-BLK) for long range applications or when a larger prism is needed
- ▶ Rain hood helps keep the

- prism clean to ensure continual measurements over a long measuring cycle
- ▶ The flat bottom of the L-Bracket is a large 2.3 x 3.4 inch (58.24 x 86.36 mm) with five holes for mounting to a variety of surfaces
- ▶ Components available individually so you can configure your specific needs

- ▶ The system is compatible with all M20 screw-in type prism canisters
- ▶ Center pivot hole is 3/8 inch (9.5 mm), the four screw holes are 4.5 mm OD
- ▶ Features include a -40 mm offset, ± 2 mm, ability to pivot in two axes, stainless-steel locking
- ▶ System weighs 1.55 lb (0.70 kg)

Part No.	Description	
6603-00	Complete Walleye Prism System with Prism and 5/8 x 11 Adapter	
6603-01	Complete Walleye Prism System with Prism and M8 Adapter	
6603-00-050	L-Bracket Assembly Only	
6603-00-005-TMB	Rain Hood Only	
6603-01-051	M8 Adapter with Screws and Washer	

360 PRISM

Lightweight and inexpensive, made to be set up and left for extended periods



Soft Case

Hard Case

FEATURES & BENEFITS

- ▶ Compatible with Leica instruments and offsets
- ▶ Prism accuracy <5 seconds

- ▶ Pointing accuracy <2mm to face of prism
- ▶ Range up to 2000ft( 600M )
- ▶ Prism Height 86mm
- ▶ Push Button Quick Release

- ▶ Male 5/8-11 thread on top
- ▶ Carrying case included, hard and soft case
- ▶ Weight 1.25 lb (0.6kg)

6406-01 — PRISM, 360, 86MM, +23.1MM PC

MINI 360 PRISM KIT

Lightweight and inexpensive, made to be set up and left for extended periods



FEATURES & BENEFITS

- ▶ Compatible with Leica instruments and offsets
- ▶ Prism accuracy <5 seconds
- ▶ Prism Offset +30 mm

- ▶ Sliding Circular Vial, sensitivity 40 minutes
- ▶ Includes 4 30cm extensions with 5cm point, 1/4-20 threads
- ▶ Carrying case included

- ▶ Ceiling hook included
- ▶ Kit weight 1.2 lbs (0.55kg)

6406-02 — PRISM, MINI 360, KIT, +30mm PC

### Mini Prisms

Lightweight and inexpensive, made to be set up and left for extended periods

- ▶ Lightweight and inexpensive, made to be set up and left for extended periods
- ▶ Features a 60 mm diamond pattern sheeting and a 2 mm offset
- ▶ Use for distances up to 492 ft (150 m)
- ▶ Feature an 86 mm height
- ▶ Fits Swiss-style male tips or Quick Release adapters
- ▶ Weighs 0.17 lb (0.08 kg)



**6600-01 — Small Tilting Mini Prism - Diamond Pattern**

- ▶ Features a 60 mm diamond pattern with Crosshairs sheeting and a 2 mm offset
- ▶ Use for distances up to 492 ft (150 m)
- ▶ Features an 86 mm height
- ▶ Fits Swiss-style male tips or Quick Release adapters
- ▶ Weighs 0.15 lb (0.07 kg)



**6600-03 — Diamond Pattern with Crosshairs**

- ▶ Use for distances up to 492 ft (150 m)
- ▶ Features a 25 mm mini prism for longer distances up to 2,000 ft (609.6 m)
- ▶ Features an 86 mm height
- ▶ Fits Swiss-style male tips or Quick Release adapters
- ▶ Offset 17.5 mm
- ▶ Weighs 0.23 lb (0.10 kg)



**6600-04 — Small Tilting 25 mm Mini Prism**

- ▶ This Prism series is ideal for deformation and mining surveys or wherever permanent mounting is needed
- ▶ This design makes mounting and pointing easy on uneven surfaces
- ▶ Mounting Arm allows tilt up to 240 degrees and Prism mount allows 360 degrees rotation
- ▶ Rechargeable battery
- ▶ The two Mounting holes are spaced 1.75" (44.4mm) apart
- ▶ Mounting holes are 0.328" (8.3mm) diameter
- ▶ Two Prism mounting holes, spaced 1.75" (44.4mm) apart
- ▶ Pivot and Prism mounting bolts are 8MM stainless steel with lock washers
- ▶ 6mm Hex wrench included
- ▶ Rain Hood included with 6603-05



- ▶ The 25 mm copper-coated prism is permanently bonded to the holder making it water and dust proof
- ▶ Features a black anodized aluminum holder
- ▶ Tilting screw uses an 8 mm hex wrench to loosen and tighten it
- ▶ Mounting hole is 10.3 mm (0.406 inch) in diameter
- ▶ Design makes mounting and pointing simple
- ▶ Centering accuracy 1.5 mm
- ▶ -25 mm offset
- ▶ Weighs 0.45 lb (0.20 kg)



**6600-02 — 25 mm 'L-Bar' Copper-Coated Mini Prism**

- ▶ The 25 mm silver-coated prism is permanently bonded to the holder making it water and dust proof
- ▶ Features a black anodized aluminum holder
- ▶ Tilting screw uses an 8 mm hex wrench to loosen and tighten it
- ▶ Mounting hole is 10.3 mm (0.406 inch) in diameter
- ▶ Design makes mounting and pointing simple
- ▶ Centering accuracy 1.5 mm
- ▶ -25 mm offset
- ▶ Weighs 0.45 lb (0.20 kg)



**6600-05 — 25 mm 'L-Bar' Silver-Coated Mini Prism**

Part No.	PRISM SIZE	COATED	WEIGHT
6603-05	62 mm	Silver	1.15 lbs (0.52 kg)
6603-06	25 mm	Copper	0.50 lbs (0.23 kg)

### Quick Release Adapters

Lightweight and inexpensive, made to be set up and left for extended periods



#### FEATURES & BENEFITS

- ▶ 6601-Series Quick Release Adapters are made of T-303

stainless steel with machined threads that attach to corresponding Anchor Bolts or

the 6602-Series rebar bolts

- ▶ Weighs 0.10 lb (0.05 kg)

- 6601-01 — 1/4 x 20 Threads
- 6601-02 — 3/8 x 16 Threads
- 6601-03 — M8 Threads
- 6601-04 — M12 Threads

### Prism: Dual Adjustable

Allows accurate measurements from two or more directions or stations



#### FEATURES & BENEFITS

- ▶ For mining, tunneling, monitoring and rail
- ▶ Minimal horizontal angle is 84° (Hex tool included)
- ▶ Compatible with standard surveying 5/8 x 11 accessories

- ▶ Holders can be stacked for more than two prisms or an GNSS Receiver can be connected on the top 5/8 x 11 stud so an GNSS measurement can also be made

- ▶ Includes two 62 mm silver coated, water-resistant prisms, accuracy < 2 arc seconds
- ▶ Prism holder is machined from 303 stainless-steel
- ▶ Zero (0) prism offset, ±1 mm
- ▶ Weighs 2.60 lb (1.18 kg)

**6603-03 — Adjustable Dual Prism**



Part No. 6603-03



**Prism Assembly Components**

Customize your own prism solution

- ▶ 62 mm Nitrogen filled prism with hermetically sealed canister
- ▶ Features <5-second accuracy



6411-00

- ▶ 62 mm copper-coated prism with sealed canister
- ▶ Features <5-second accuracy



6411-02-BLK

- ▶ 62 mm silver-coated prism with heavy-duty sealed canister
- ▶ Features <5-second accuracy



6411-03-BLK

- ▶ 62 mm silver-coated prism with heavy-duty sealed-canister
- ▶ Features <2-second accuracy



6411-04-BLK

- ▶ 62 mm silver-coated strobe prism
- ▶ Features 0.5-second flash
- ▶ Sanyo CR 1/3N Battery



6416-00

- ▶ 25 mm copper-coated prism in a canister
- ▶ Weighs 0.06 lb (0.03 kg)



6020-01

- ▶ 25 mm silver-coated prism in a canister
- ▶ Weighs 0.06 lb (0.03 kg)



6020-02

**2159 Series Traverse Kits**



**FEATURES & BENEFITS**

- ▶ All products made in our European manufacturing facility at Budapest, Hungary
- ▶ Prisms, 64.9mm, are either Copper or Silver Coated
- ▶ Beam Deviation accuracy either <5 or <2 second
- ▶ Anti-Reflective coating, AR, on front surface of the prism (helps prevent short range reflection errors)

- ▶ Dual sided Target Plate, short or long range. Black/Flo-Yellow color
- ▶ High Precision Rotating Tribach Adapters with 45" Plate Vial
- ▶ Optical Plummet Accuracy 0.5mm/1.5M, 2X Magnification, circle reticule
- ▶ Target Height 196mm
- ▶ Centering accuracy 1.1mm
- ▶ Standard three screw Tribach with 8' vial

- ▶ Carrying case, bright orange with foam inserts
- ▶ Weight:  
Traverse kit itself: 3.96 lbs (1.8 kg)  
Orange box: 4.62 lbs (2.1 kg)  
Total: 8.58 lbs (3.9 kg)



PART NO.	DESCRIPTION	
2159-10 TRAVERSE KIT	-34MM COPPER PRISM W/AR,<5"	
2159-11 TRAVERSE KIT	-34MM COPPER PRISM W/AR,<2"	
2159-12 TRAVERSE KIT	-35MM SILVER PRISM W/AR,<5"	
2159-13 TRAVERSE KIT	-35MM SILVER PRISM W/AR,<2"	
2159-14 TRAVERSE KIT	SX10 -35MM SILVER PRISM W/AR,<5"	
2159-15 TRAVERSE KIT	SX10 -35MM SILVER PRISM W/AR,<2"	

### Single Prism Traverse Kit



#### FEATURES & BENEFITS

- ▶ Includes a 62 mm prism with silver-coated canister (6400-10, see page 31)
- ▶ The adjustable (and reversible) tilt target has a sighting collimator for precise pointing and has
  - ▶ 0, -30, and -40 offsets
- ▶ The kit comes with a rotating tribrach adapter (2153-10, see page 39) that is compatible with all prisms with a 24.9 mm bayonet base
- ▶ Features a 2.5X twist focus optical plummet and a 60-second adjustable plate vial
- ▶ Prism has <5 arc seconds angle deviation
- ▶ The adapter has a precision machined axis that rotates 360°
- ▶ The height is 180 to 200 mm and over the point accuracy is 0.5 mm at 1.5 m
- ▶ Also included is a tribrach (2153-04, see page 39) which features three screw-leveling with center line, an 8-minute circular vial, and 5/8 x 11 base thread
- ▶ Includes hard shell case
- ▶ Weighs 9.95 lb (4.51 kg)

2159-01-BLK — Single Prism Traverse Kit

2159-050 — Hard Shell Traverse Carrying Case (included in kit or sold separately)



### Precision Traverse Kit for 155 mm Heights

For Nikon Nivo™ XF, XS and Trimble C3, C5 M3 Total Stations



#### FEATURES & BENEFITS

- ▶ Preset to a 155 mm height making it compatible with Nikon NIVO™ Series Total Stations
- ▶ Kit includes a 62 mm prism assembly
- ▶ Prism has <5 arc seconds angle deviation and a silver-coated prism to resist fogging
- ▶ Includes rotating tribrach adapter with a 2.5X pull focus optical plummet and a 45-second adjustable plate vial
- ▶ Adapter has a precision machined axis that rotates 360°
- ▶ Tilt target has 0 or -30 offsets
- ▶ Over the point accuracy is 0.5 mm at 1.5 meters
- ▶ Also included is a (2153-04, see page 39) tribrach which features three-screw-leveling with center line, an 8-minute circular vial, and 5/8 x 11 base thread
- ▶ Kit comes in a bright orange, hard shell carrying case (2159-050, see page 40) which features high density foam inserts, nickel plated latches and backpack straps
- ▶ Weighs 9.95 lb (4.51 kg)

2159-04-BLK — Precision Traverse Kit for 155 mm Heights





GeoDesy: premier technology

**Tribrach Adapter**

- ▶ Height: 136.2 mm
- ▶ Weighs 0.88 lb (0.40 kg)



FPT144-BLK — Traverse Tribrach Adapter & GPS Carrier w/ Swiss-Style Locking Pin

**Fixed Tribrach Adapter**

- ▶ Height: 145.5 mm
- ▶ Weighs 1.10 lb (0.50 kg)



FPT146-BLK — Fixed Tribrach Adapter with 5/8 x 11 Stud

**Tribrach Adapter**

- ▶ Height: 40 mm
- ▶ Weighs 0.62 lb (0.28 kg)



FPT247-BLK — Fixed Tribrach Adapter & GPS Carrier with 5/8 Stud

**Tribrach Adapter**

- ▶ Includes rotating lock screw
- ▶ Height: 32 mm
- ▶ Weighs 1.10 lb (0.50 kg)



A455 — Tribrach Adapter with Rotating Lock Screw

**Tribrach Adapter**

- ▶ Non-Rotatable
- ▶ Height: 22.5 mm
- ▶ Weighs 0.66 lb (0.30 kg)



A452 — Non-Rotatable 5/8 x 11 Tribrach Adapter

**Tribrach Adapter**

- ▶ Height: 23 mm (slim)
- ▶ Rotating, Friction
- ▶ Weighs 0.79 lb (0.36 kg)



A458 — Rotatable Tribrach Adapter

**Tribrach Adapter**

- ▶ Height: 32 mm
- ▶ Rotating, Friction, Rotatable
- ▶ Weighs 1.06 lb (0.48 kg)



A456 — Tribrach Adapter



Concentric Circle Reticule instead of Cross Reticule – IP65 Rated

- ▶ Shortest focal distance: 0.35 mm
- ▶ Operating Temperature: -20°C to +50°C
- ▶ Magnification: 2x
- ▶ Image: Erect
- ▶ Height: 136.2 mm
- ▶ Accuracy: 0.5 mm/1.5 m
- ▶ Vial Sensitivity: 45"/2 mm
- ▶ Swiss-Style quick lock pin
- ▶ Weighs 1.41 lb (0.64 kg)



RT481WON-BLK — Rotatable Prism Holder with Optical Plummet and Swiss-Style Locking Pin

- ▶ Shortest focal distance: 0.35 mm
- ▶ Operating Temperature: -20°C to +50°C
- ▶ Magnification: 2x
- ▶ Image: Erect
- ▶ Accuracy: 0.5 mm/1.5 m
- ▶ Height 100 mm
- ▶ Vial Sensitivity: 45"/2 mm
- ▶ Bayonet style tip
- ▶ Weighs 1.41 lb (0.64 kg)



RT482WON-BLK — Rotatable Prism Holder with Optical Plummet and Bayonet Tip

- ▶ Shortest focal distance: 0.35 mm
- ▶ Operating Temperature: -20°C to +50°C
- ▶ Vial Sensitivity: 45"/2 mm
- ▶ Magnification: 2x
- ▶ Image: Erect
- ▶ Height 70 mm
- ▶ Accuracy: 0.5 mm/1.5 m
- ▶ 5/8 x 11 threaded stud
- ▶ Weighs 1.23 lb (0.56 kg)



RT484WON-BLK — Rotatable Prism Holder with Optical Plummet and 5/8 x 11 Threaded Stud



Prism Holders

- ▶ Swiss-Style quick lock pin
- ▶ Height: 136.2 mm
- ▶ Vial: 45"/2 mm
- ▶ Weighs 1.21 lb (0.55 kg)



RT481W-BLK — Rotatable Prism Holder without Optical Plummet with Swiss-Style Locking Pin

- ▶ Bayonet tip
- ▶ Height: 100 mm
- ▶ Vial: 45"/2 mm
- ▶ Weighs 1.21 lb (0.55 kg)



RT482W-BLK — Rotatable Prism Holder without Optical Plummet with Bayonet Tip

- ▶ 5/8 x 11 threaded stud
- ▶ Height: 70 mm
- ▶ Weighs 1.06 lb (0.48 kg)



RT484W-BLK — Rotatable Prism Holder without Optical Plummet with 5/8 x 11 Threaded Stud

**GeoDesy**  
by SECO

### NEW Tribrach Technology: High Precision Laser Tribrachs



This tribrach is green in more ways than one – it includes a rechargeable, replaceable battery. Most laser tribrachs' batteries have to be replaced in less than an hour, but this one can be used continuously for 6-7 hours.

This new High Precision tribrach is available with either a red or green laser. The green laser is easily visible in extremely dark conditions and also in extremely bright, sunny conditions, making it ideal for surveyors doing work from tunnels to bridges.

SECO offers Geodesy by SECO tribrachs in two different models; High-Precision and Standard-Precision.

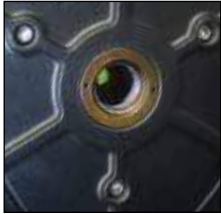

#### FEATURES & BENEFITS

- ▶ One rechargeable, replaceable battery pack is included
- ▶ Other battery packs available (sold separately)
- ▶ Up to 7 hours of continuous operation without battery charge or replacement
- ▶ Battery level indication
- ▶ Green and Red laser version
- ▶ High contrast laser dot
- ▶ Laser dot size: 1.5mm over 1.5 meters or equivalent in imperial
- ▶ 1mm at 1.5m centering accuracy
- ▶ Micro USB charging, cable included
- ▶ 3cc (1 arc sec) Geodesy by Seco MOM Tribrach
- ▶ 8' vial
- ▶ Operating temperature -10C - +50C (14F - 122F)
- ▶ Laser class: Class 1M laser
- ▶ Battery: 500mAh Li-Po battery
- ▶ Charge temp: 0°C - 45°C
- ▶ Operating temperature -10C - +50C (14F -122F)
- ▶ Operating height: 0.3m-5m operation
- ▶ Vial: 8' circular
- ▶ Connection: 5/8 x 11
- ▶ IP 65 ruggedness rating

- 2154-04-BLK — High-Precision Green Laser Tribrach
- 2154-02-BLK — High Precision Red Laser Tribrach
- 2154-BATT — Replaceable, Rechargeable Battery Pack



**GeoDesy**  
by SECO

### Quality European-made tribrachs allows your equipment to stay steady



#### FEATURES & BENEFITS

- ▶ SECO now offers Geodesy-MOM tribrachs in two different models; our High-Precision tribrach and now the Standard-Precision tribrach
- ▶ European-made with a precise and repeatable locking mechanism for fast and solid accessory connection
- ▶ A center line on each of the leveling screws allows the user to balance the lengths of the leveling screws
- ▶ All tribrachs feature 5/8 x 11 threaded base plates and 8-minute circular vials
- ▶ High-precision tribrachs feature an error in angle measurement (hysteresis) is under 3 cc (60 Ncm torsion moment and 12 kg vertical load), standard tribrach is 5 cc
- ▶ The 2152-06-BLK has a shortest focus distance of 0.35 m and an accuracy of 0.5 mm / 1.5 m
- ▶ Features 2X magnification and an erect image
- ▶ Operating temperature is -20°C to +50°C (-4°F to +122°F)
- ▶ IP 65 ruggedness rating

- 2152-06-BLK — High-Precision Tribrach with Optical Plummet
- 2153-06-BLK — High-Precision Non-Optical Plummet Tribrach
- 2152-07-BLK — Standard Precision Tribrach with Optical Plummet
- 2153-07-BLK — Standard Precision Non-Optical Plummet Tribrach



**Tribrachs & Adapters**

Contractor-series tribrachs and adapters

- ▶ Bright 650-nm focused red laser dot
- ▶ Circular vial w/ 8-minute sensitivity
- ▶ Standard three-prong forced centering with center lines
- ▶ Included is a standard 3 volt CR2 lithium battery
- ▶ Weighs 1.65 lb (0.75 kg)
- ▶ Laser class 2
- ▶ These tribrachs do not fit Trimble "S6" Series Instruments



2153-02-BLK — Laser Tribrach

- ▶ The Optical Plummet Twist Focus Tribrach features twist focus (2.5X mag) and leveling screws with center line
- ▶ Features an 8-min vial, three-prong forced centering and a 5/8 x 11 base
- ▶ Tribrach has a focusing range of 1.5 to 50 ft (0.5 to 15 m)
- ▶ These tribrachs do not fit Trimble "S" Series Instruments
- ▶ Weighs 1.85 lb (0.84 kg)



2152-04-BLK — Tribrach with Optical Plummet   
2153-04-BLK — Tribrach w/o Optical Plummet

- ▶ Allows adjusting of prism height by moving the threaded brass insert in the adapter
- ▶ Fits all tribrachs
- ▶ Weighs 1.91 lb (0.87 kg)
- ▶ 50-75 mm



2071-00 — Prism H.T. Adapter

- ▶ This adapts retro prisms to Swiss style tribrachs and has a removable Zeiss plug and locking screw
- ▶ Fits all tribrachs
- ▶ Weighs 1.75 lb (0.80 kg)
- ▶ Height 34.5 mm



2070-00 — Rotating Tribrach Adapter

- ▶ This rotating friction top tribrach adapter allows the prism to be pointed after installation in the tribrach
- ▶ Fits all tribrachs
- ▶ Weighs 0.90 lb (0.41 kg)
- ▶ Height 32 mm



2020-00 — Rotating Tribrach Adjuster

- ▶ Use adapter for mounting retro prisms and tripod mounted target systems
- ▶ Fits all tribrachs
- ▶ Weighs 0.50 lb (0.23 kg)
- ▶ Height 24.5 mm



2010-00 — Fixed Tribrach Adapter

- ▶ Use for adjusting optical plummet tribrachs and tribrach bubbles
- ▶ Machined black anodized aluminum features a 2-minute bubble
- ▶ Weighs 1.30 lb (0.59 kg)



2002-00 — Tribrach Adjuster

- ▶ Check and adjusting optical plummet tribrachs in the office
- ▶ Precision-machined, black anodized aluminum
- ▶ Weighs 0.70 lb (0.32 kg)



2001-00 — Tribrach Adjusting Cylinder

**European Style Tribrach**

Choose with or without Optical Plummet



**FEATURES & BENEFITS**

- ▶ This tribrach features 2X magnification and a twist focus
- ▶ Its reticule is composed of two small concentric circles

- ▶ With a sighting distance of 0.3 m to 15 m, the tribrach has an accuracy of 0.5 mm per 1.5 m
- ▶ Locking forced-centering knob and a 5/8 x 11 base and an 8-minute circular vial

- ▶ Choose with or without an optical plummet
- ▶ Weighs 1.55 lb (0.70 kg)

2152-05-BLK — European-Style Tribrach with Optical Plummet   
2153-05-BLK — European-Style Tribrach Non-Optical Plummet Tribrach

**Traverse Tribrach Adapter**

Compatible with all 24.9 mm bayonet base prisms



2153-10-051 Quick Release Adapter



2153-10-050 Male 5/8 x 11 Adapter

**FEATURES & BENEFITS**

- ▶ The optical plummet is twist-focus with 2.5X magnification
- ▶ 60-second adjustable plate vial

- ▶ Precision-machined axis rotates 360°
- ▶ Compatible with all prisms with a 24.9 mm bayonet base

- ▶ The adjustable height is 100 to 120 mm — fits all standard three-prong tribrachs
- ▶ Over point accuracy is 0.5 mm at 1.5 m
- ▶ Weighs 1.70 lb (0.77 kg)

2153-10-BLK — Traverse Tribrach Adapter



### TRI-MAX® TRIPODS

The Tri-Max® is the only surveying-grade tripod with certified accuracy – highly recommended for all servo-driven and robotic total stations, 3-D laser scanners or construction lasers.



#### Fiberglass Tri-Max Tripods

Certified accurate premier instrument tripod

#### FEATURES & BENEFITS

- ▶ The revolutionary design of this tripod series means this tripod will meet ISO standard (12858-2-H) right out of the box, and after years of field use
- ▶ The shape and size of the foot are designed to allow for a solid placement on any terrain
- ▶ Features a round head with large center hole to facilitate an easy set-up over a point
- ▶ Long lasting fiberglass

- ▶ The large 'footbed' is there to facilitate solid planting for stability
- ▶ Features positive locking systems
- ▶ A retaining system—which prevents leg kick out and accidental falls on slick surfaces—is stored on the inside of the leg and can be left in place when the tripod is not in use

- ▶ The foot is equipped with a replaceable point and a retention loop for use with a safety strap
- ▶ Tri-Max tripods can handle equipment up to 30 kg (65 lb)
- ▶ Collapsed: 113 cm (44.5 in) except 90560: 54 in (1.37 m)

#### APPLICATIONS

- ▶ Robotics
- ▶ Scanning
- ▶ Leveling



Part No.	LOCK TYPE	LEGS	WEIGHS	EXTENSION	HEAD	HARDWARE	
90550	Quick Clamp	Fiberglass	17.00 lb (7.70 kg)	71 in (1.8 m)	Flat	Black	
90551	Screw Clamp	Fiberglass	17.00 lb (7.70 kg)	71 in (1.8 m)	Flat	Black	
90553	Dual Clamp	Fiberglass	17.00 lb (7.70 kg)	71 in (1.8 m)	Flat	Black	
90560	Dual Clamp	Fiberglass	20.00 lb (9.00 kg)	91 in (2.3 m)	Flat	Black	

**Universal Tri-Max Elevator Tripod**

A gear box controls the lift and descent so the center column cannot free fall



90557-050

**FEATURES & BENEFITS**

- ▶ SECO's Universal Tri-Max® Elevator Tripod features a working height range of 4.10 ft (1.20 m) collapsed to 8.60 ft (2.62 m) extended with the center column at full height
- ▶ Center column independently lifts 1 meter (90558-050)
- ▶ A gear box controls lift and descent so the center column cannot free fall
- ▶ The 5/8 x 11 mounting head is removable and adjustable in azimuth direction
- ▶ Fiberglass Legs

- ▶ Additional 1 meter section may be added for a total recommended height of 10 ft (3 m) for instruments under 15 lb (6.80 kg)
- ▶ Sections can move up or down
- ▶ Machined-aluminum elevator column and fiberglass legs makes for a robust and easy-to-use laser instrument tripod
- ▶ Stable for instruments up to 25 lb (11.33 kg) under most conditions
- ▶ Weighs 29.00 lb (13.20 kg)
- ▶ Collapsed length 53 in

**APPLICATIONS**

- ▶ Robotics
- ▶ Scanning
- ▶ Leveling

- 90558 — Universal Tri-Max Elevator Tripod
- 90558-050 — 1 Meter Extension for Universal Tri-Max Elevator Tripod
- 90557-050 — Tri-Max Wheel Kit
- 90558-052 — Adaptor Plate, 3/8-16



**Short Tri-Max**

Standard Tri-Max quality in a smaller size



**FEATURES & BENEFITS**

- ▶ The Tri-Max® Short Quick Clamp Tripod features the exact same design and construction as the full-size (90550) Tri-Max but it is more portable

- ▶ Extends to 5.67 ft (1.73 m)
- ▶ Collapses to 3.44 ft (1.05 m)
- ▶ Highly recommended for all servo-driven and robotic total stations and 3-D laser scanners
- ▶ Fiberglass legs
- ▶ Weighs 15.40 lb (7.00 kg)

**APPLICATIONS**

- ▶ Robotics
- ▶ Scanning
- ▶ Leveling

- 90550-S — Short Fiberglass Tri-Max Tripod

### Premier Fiberglass Tripod

Improved quality and stability for more accurate measurements



#### FEATURES & BENEFITS

- ▶ 6-5/8 inch (16.83 cm) flat round head with large center hole
- ▶ (2-5/8 inch, 6.67 cm) to facilitate an easy set-up over a point
- ▶ Foot is equipped with a replaceable point made of hardened steel

- ▶ Standard 5/8 x 11 threaded brass instrument stud
- ▶ Snap cap to protect tripod head
- ▶ Extends to 70.75 inches (179 cm)
- ▶ Collapses to 43.75 inches (111 cm)
- ▶ Made in North America under strict quality controls

- ▶ Includes a comfortable shoulder strap for carrying over longer distances

#### APPLICATIONS

- ▶ Ideal for mounting theodolites, lasers, auto levels, or total stations

PART NO.	LOCKING	LEGS	EXTENDS	COLLAPSES	WEIGHS	COLOR	
90582	Dual Lock	Fiberglass	70.75 in (179 cm)	43.75 in (111 cm)	13.60 lb (6.16 kg)	Orange (shown)	

### Extra-Tall Fiberglass Elevator Tripod

Locking leg stabilizers provide greater stability



#### FEATURES & BENEFITS

- ▶ Tripod has a fully-extended leg and center column height of 12.40 ft (3.80 m) and a collapsed height of 5.97 ft (1.82 m)
- ▶ Features an adjustable center column that gives you 3.7 ft (1.12 m) of lift
- ▶ Lockable leg stabilizer struts,

- dual clamps, screw clamp and quick clamp, along with dual metal and rubber leg points and handy leg strap create greater stability
- ▶ Detachable round head plate, with a 5/8 x 11 stud, gives your instrument a sturdy platform
- ▶ Column can hold 66 lb (30 kg) when collapsed, and 15.4 lb (7 kg) when elevating

- ▶ Legs and dowels are constructed of fiberglass for durability, strength and resistance to weathering
- ▶ Includes leg straps
- ▶ Weighs 33.10 lb (15.00 kg)

#### APPLICATIONS

- ▶ Use with lasers, scanners, machine control or other instruments

5321-17-ORG — Extra-Tall Fiberglass Elevator Tripod

### Birch Wood / Fiberglass Hybrid Tripod

Improved kiln dried birch wood / fiberglass hybrid tripod models



#### FEATURES & BENEFITS

- ▶ Combination of hardwood legs with fiberglass dowels provides stability and weather resistance
- ▶ Large aluminum head and leg hinges provide stable mounting base

- ▶ Double banded extension legs and large positive locking quick clamp for extra stability
- ▶ Powder coated wear-resistant metal hardware
- ▶ Aluminum shoe with hardened steel replaceable shoe points

- ▶ Includes: plastic head cap for protection, heavy-duty poly-webbing shoulder strap for ease of carrying to the job site (not shown)

PART NO.	MATERIAL	EXTENDED	COLLAPSES	CLAMPING	HEAD	WEIGHT	COLOR	
5302-13-BLK	Wood / Fiberglass	69" (175.26 cm)	43" (109 cm)	Quick Clamp	Triangle	16.5 lb (7.48 kg)	Black	
5302-13-ORG	Wood / Fiberglass	69" (175.26 cm)	43" (109 cm)	Quick Clamp	Triangle	16.5 lb (7.48 kg)	Orange	
5402-13-BLK	Wood / Fiberglass	72" (183 cm)	43" (109 cm)	Twist Locks	Triangle	15.7 lb (7.14 kg)	Black	
5402-13-ORG	Wood / Fiberglass	72" (183 cm)	43" (109 cm)	Twist Locks	Triangle	15.7 lb (7.14 kg)	Orange	

Disclaimer: the full-view tripod is a composite photograph for illustrative purposes

### Heavy-Duty Birch Wood Tripods

Improved kiln dried birch wood tripod models



Disclaimer: the full-view tripod is a composite photograph for illustrative purposes

#### FEATURES & BENEFITS

- ▶ Made of high quality birch hardwood with wide-frame extension legs and 123mm (0.91") dowels
- ▶ Large 6.5" (165mm) aluminum head

- ▶ Twist locks with die cast leg bands for maximum locking
- ▶ Quick clamps, adjustable, for quick set ups
- ▶ Powder Coated metal fittings
- ▶ Aluminum shoe with hardened steel replaceable shoe points

- ▶ Instrument Fastener brass 5/8-11
- ▶ Includes heavy-duty poly-webbing shoulder strap for ease of carrying to the job site (not shown)

PART NO.	MATERIAL	EXTENDED	COLLAPSES	CLAMPING	HEAD	WEIGHT	COLOR	
5220-13-BLK	Wood	68" (173 cm)	43" (109 cm)	Dual Locks	Round	16.5 lb (7.48 kg)	Black	
5220-13-ORG	Wood	68" (173 cm)	43" (109 cm)	Dual Locks	Round	16.5 lb (7.48 kg)	Orange	
5420-13-BLK	Wood	72" (183 cm)	43" (109 cm)	Twist Locks	Round	15.0 lb (6.82 kg)	Black	
5420-13-ORG	Wood	72" (183 cm)	43" (109 cm)	Twist Locks	Round	15.0 lb (6.82 kg)	Orange	

### Aluminum Elevator Tripods

Locking leg stabilizers provide greater stability



#### FEATURES & BENEFITS

- ▶ Aluminum elevator tripods have smooth operating adjustable center columns
- ▶ Black hardware
- ▶ Tough kick-in cleats and points

- ▶ Features a built-in circular vial in the instrument head and safety chains on the legs to prevent slipping on hard surfaces

#### APPLICATIONS

- ▶ Ideal for lasers, scanners, machine control or other instruments

PART NO.	LOCK TYPE	HEAD	EXTENDS	COLLAPSES	WEIGHS	
5321-16-BLK	Quick Clamp	Elevator / Round	7.60 ft (2.3 m)	4.26 ft (1.26 m)	16.30 lb (7.39 kg)	

### Square Leg Aluminum Tripods

Heavy-duty aluminum square leg tripods offer stability and accuracy



#### FEATURES & BENEFITS

- ▶ Equipped with square outer dowels for a more secure lock
- ▶ These tripods are equipped with a 5/8 x 11 threaded adapter for convenient mounting of instruments

- ▶ They're built to last—with heavy construction throughout—and are designed to withstand rigorous field conditions

#### APPLICATIONS

- ▶ Ideal for mounting theodolites, lasers, auto levels, or total stations

PART NO.	LOCK TYPE	LEGS	WEIGHS	EXTENSION	HEAD	HARDWARE	
5301-31-BLK	Quick Clamp	Aluminum (Square)	9.70 lb (4.40 kg)	64 in (1.60 m)	Triangle / Flat	Black	
5301-31-ORG	Quick Clamp	Aluminum (Square)	9.70 lb (4.40 kg)	64 in (1.60 m)	Triangle / Flat	Orange	



### Round Leg Aluminum Tripods

Sturdy and lightweight tripods for many applications



#### FEATURES & BENEFITS

- ▶ These tripods accommodate 5/8 x 11 instruments and are designed for all types of jobs
- ▶ Choices include: Flat or dome head, standard, elevator or mini tripod size

- ▶ The telescopic legs allow for setup at various heights and are available with orange or black hardware (on some models)

#### APPLICATIONS

- ▶ Ideal for mounting theodolites, lasers, auto levels, or total stations

PART NO.	LOCK TYPE	LEGS	WEIGHTS	EXTENSION	HEAD	HARDWARE	
5301-21-ORG	Quick Clamp	Aluminum (Round)	9.35 lb (4.24 kg)	65 in (1.65 m)	Triangle / Flat	Orange	
5301-21-BLK	Quick Clamp	Aluminum (Round)	9.35 lb (4.24 kg)	65 in (1.65 m)	Triangle / Flat	Black	
5301-25-BLK	Quick Clamp	Aluminum (Round)	7.45 lb (3.38 kg)	63.5 in (1.60 m)	Triangle / Flat	Black	
5301-24-BLK	Quick Clamp	Aluminum (Round)	6.75 lb (3.06 kg)	27 in (68.65 cm)	Triangle / Flat	Black	
5311-21-ORG	Quick Clamp	Aluminum (Round)	7.60 lb (3.45 kg)	63.5 in (1.60 m)	Dome	Orange	
5401-21-BLK	Screw Clamp	Aluminum (Round)	8.13 lb (4 kg)	67 in (1.68 m)	Triangle / Flat	Black	

### Tripod Dolly

Moves a tripod quickly to the next shot without breaking down the instrument



#### FEATURES & BENEFITS

- ▶ Tripod Dolly for all surveying tripods
- ▶ Easily maneuvered through doorways

- ▶ Folds for portability, 25.5" folded
- ▶ Convenient carrying handle
- ▶ Locking 5" diameter, hard rubber wheels; ball bearing casters with cable guards

- ▶ Adjustable Velcro straps to keep tripod secure
- ▶ Load capacity 132 lbs
- ▶ Weight 17 lbs

Note: Tripod not included with dolly.

5610-15 — Tripod Dolly



### Cross Reference Table

Bags and Cases For Instrument Tripods

BAGS	PAGE NUMBER	TRIPODS WILL FIT	
8150-20-ORG	Pg. 67	Every Tripod Except for; 90558, 90560, 5321-17-ORG	
8153-10-ORG	Pg. 67	5321-17-ORG and 5115-00	
8154-00-ORG	Pg. 67	5119-00	
8154-10-ORG	Pg. 67	5300-11 and 5300-12	
8154-11-ORG	Pg. 67	Every Tripod Except for; 90558, 90560, 5321-17-ORG	
8154-12-ORG	Pg. 67	5119-10	



**Instrument Tripod Accessories**

- ▶ Designed to provide the extra stability required when working indoors on concrete and other hard surfaces
- ▶ Made of heavy-duty aluminum
- ▶ Measures 35 x 35 x 35 inches (889 x 889 x 889 mm)
- ▶ Collapses for compact storage
- ▶ Rubber o-ring fits over the foot of the tripod for extra stability
- ▶ Weighs 3.00 lb (1.36 kg)

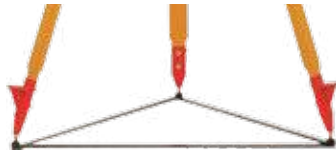
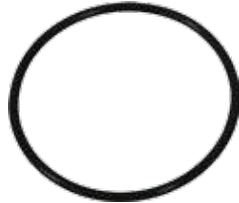

5610-00 — Tripod Stabilizer 

- ▶ This Stabilizer helps prevent tripod legs from slipping when used on hard, slick surfaces.
- ▶ Lightweight and portable
- ▶ Collapses to 26 3/8" (67 cm)
- ▶ Opens to a three point star with 26 1/2" (67 cm) legs
- ▶ Two 0.315" (8 mm) hole in each leg, one at 35 cm from center and one at 65 cm.
- ▶ Anodized aluminum legs
- ▶ O-rings to hold tripod foot in place
- ▶ Center opening 1 7/8" (45 mm)
- ▶ Weight 1.05 lbs (0.48 kg)

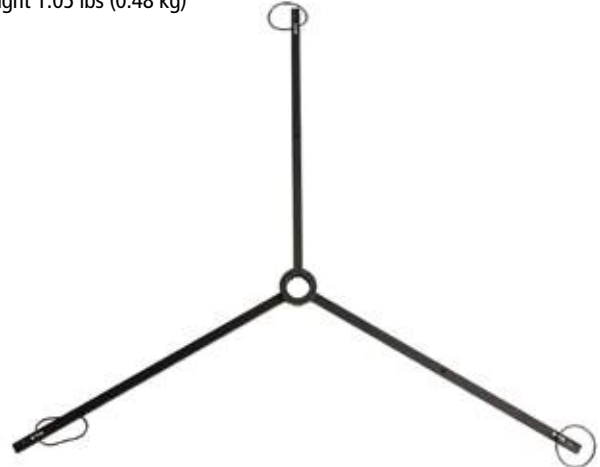

5610-01 — Tripod Stabilizer 

- ▶ Lightweight and portable, keep your tripod level in all surface conditions
- ▶ Simple to use
- ▶ Features cleats to minimize slipping
- ▶ Attached bungee cables enable easy carrying, hanging or placement
- ▶ Sold in packs of three
- ▶ Each weighs 0.29 lb (0.12 kg)



5610-11 — Sta-Level Feet Tripod Stabilizer (w/ Rubber Pads) 

- ▶ Provides non-slip support for tripods
- ▶ Works on all ferrous metal surfaces
- ▶ Includes three 5-inch round ceramic magnets
- ▶ Each magnet has a tripod point connection with a bungee strap
- ▶ Handle to remove magnet from surface included
- ▶ Each magnet has 210 pull pounds
- ▶ Kit bag is included



5610-12 — Tripod Anchor Kit 

### Leveling Rod Accessories

- ▶ Use with aluminum leveling rods
- ▶ Weighs 0.50 lb (0.23 kg)



7321-050 — Leveling Rod Vial

- ▶ These replacement rod button kits fit on SECO aluminum leveling rods



70014-6 — Round 17 mm Button   
70014-7 — Round 13 mm Button w/ Ring

- ▶ 6-inch long caliper for SVR/Oval rods and CMR ruler



91014 — 6-inch Caliper for SVR/Oval Rods and CMR Ruler

- ▶ Adapt the thread size to 5/8 x 11 for mounting prisms on the LR's female adapter
- ▶ Weighs 0.20 lb (0.09 kg)



91133 — 5/8 x 11 Double Male Prism Adapter

- ▶ USL/SVR Hook



91275 — USL/SVR Hook

- ▶ Swiss-Style Prism Adapter



6601-01 — Swiss-Style Prism Adapter 1/4 x 20 Threads

- ▶ Snap-Tite® SVR Rod Level



91255 — Snap-Tite SVR Rod Level

- ▶ Snap-Tite CR Rod Level



91535 — Snap-Tite CR Rod Level

- ▶ The Leveling Plates (or Turtles as they are commonly known) are cast heavy steel and red powder painted for durability
- ▶ Other quality features include chrome plating on the dome, carrying handle and ground points
- ▶ Use to improve the accuracy of level runs in soft terrain
- ▶ Diameter 5.51 in (14 cm)
- ▶ Diameter of half ball 1.81 in (3 cm)
- ▶ Height of half ball 0.79 in (2 cm)
- ▶ Height of foot to top half ball 2.60 in (6.6 cm)
- ▶ Weighs 4.41 lb (2.00 kg)



7304-01 — Leveling Plate (Turtle)

- ▶ 5/8 x 11 Prism Mounting Adapter Kit



91258 — 5/8 x 11 Prism Mounting Adapter Kit

- ▶ This bipod features a special head that will hold a rectangular rod
- ▶ The head will fit rods with widths between 1.57 inches (39.9 mm) and 2.56 inches (65.0 mm)



5217-21-FOR — Leveling Rod Thumb Release Bipod

- ▶ This bipod features a special head that will hold a rectangular rod
- ▶ The head will fit rods with widths between 2.95 inches (74.9 mm) and 3.8 inches (96.5 mm)
- ▶ Depth: 1.75 inches (44.4 mm)



5217-20-FLY — Invar Rod Thumb Release Bipod

## SVR Brackets for Laser Receivers

Easily attaches to SVR rods



### FEATURES & BENEFITS

- ▶ Brackets are needed to attach laser sensors to the SVR rod

- ▶ Top or side brackets are available for all popular laser receiver models

### APPLICATIONS

- ▶ Use with an SVR rod to mount your laser receiver

PART NO.	MOUNT TYPE	DESIGNED FOR	
91100	Top	Universal	
91162	Top	Storm® HL700/750/450	
91163	Side	Storm HL700/750/450	

## 'E' Pattern Builder's Rods

Dual-sided lightweight rod



### FEATURES & BENEFITS







- ▶ Features a standard 'E' pattern
- ▶ Lightweight aluminum sections are in contrasting white, red and black colors and have round spring-loaded locking buttons

- ▶ Graduations are cm on the front
- ▶ Height scale is in millimeters on the back
- ▶ Includes a level vial and case

### APPLICATIONS

- ▶ Grading
- ▶ Masonry
- ▶ Site work
- ▶ Forms
- ▶ Landscaping
- ▶ Foundations
- ▶ Sewers
- ▶ Slab work

Difference is the back size has a standard scale

PART NO.	LENGTH	GRADS	WEIGHS	
7341-41	4 m	cm	3.10 lb (1.40 kg)	
7341-45*	4 m	mm	3.10 lb (1.40 kg)	
7341-51	5 m	cm / mm	3.80 lb (1.73 kg)	
7341-52	5 m	cm / inches	3.80 lb (1.73 kg)	
7341-55*	5 m	cm / mm	3.80 lb (1.73 kg)	
7341-56	5 m	UK cm / mm	3.80 lb (1.73 kg)	

## Aluminum Builder's Rods

Light and durable anodized leveling rods



### FEATURES & BENEFITS







- ▶ These aluminum leveling rods are made of a light and durable alloy
- ▶ The telescopic sections are anodized and silk-screened with moisture-resistant ink

- ▶ Each rod section uses sturdy polycarbonate buttons that lock each section when extended; the height gauge is on the back side
- ▶ Each rod includes a special level and protective bag

### APPLICATIONS

- ▶ Grading
- ▶ Masonry
- ▶ Site work
- ▶ Forms
- ▶ Landscaping
- ▶ Foundations
- ▶ Sewers
- ▶ Slab work

\*Replacement buttons PN: 70014-6 or 70014-7 (see page 48)

PART NO.	SECTIONS	LENGTH	GRADS	WEIGHS	
7321-30	3	9 ft, 9.5 in	8ths	2.40 lb (1.10 kg)	
7301-30	3	9.8 ft	10ths	2.40 lb (1.10 kg)	
7321-40	4	13 ft, 1.38 in	8ths	3.10 lb (1.40 kg)	
7301-40	4	13.12 ft	10ths	3.10 lb (1.40 kg)	
7341-40	4	4 m	5 mm	3.10 lb (1.40 kg)	
7321-50	5	16 ft, 4.75 in	8ths	3.50 lb (1.60 kg)	
7301-50	5	16.4 ft	10ths	3.50 lb (1.60 kg)	

### Surveyor's Series (SVR) Leveling Rods

Waterproof and wear-resistant

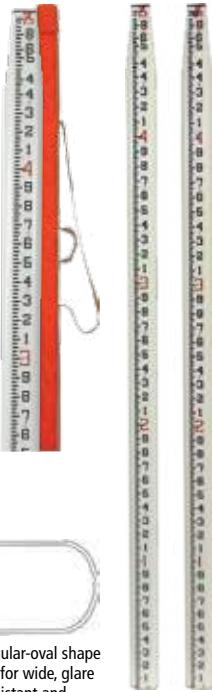

Rectangular-oval shape allows for wide, glare resistant and wear-resistant scales.

#### FEATURES & BENEFITS

- ▶ Features a new shorter collapsed length (58.5 inches on 25 ft versions) and a lighter weight
- ▶ Constructed of strong, rigid fiberglass with reinforcing ribs for added stability
- ▶ Water-resistant and non-conductive
- ▶ A tight locking mechanism features round buttons that resist jamming from sand and dirt
- ▶ Includes a 1/4 x 20 female adapter in top section

#### APPLICATIONS

- ▶ Grading
- ▶ Masonry
- ▶ Site work
- ▶ Forms
- ▶ Landscaping
- ▶ Foundations
- ▶ Sewers
- ▶ Slab work

Includes carrying case. Order 91411 for replacement carrying case – see page 68

PART NO.	HEIGHT SCALE	LENGTH	GRADS	WEIGHS	
98010	Height Scale	25 ft (7.6 m)	10ths	6.00 lb (2.72 kg)	
98011	Height Scale	25 ft (7.6 m)	8ths	6.00 lb (2.72 kg)	
98012	Height Scale	25 ft (7.6 m)	0.5 cm metric	6.00 lb (2.72 kg)	
98013	Height Scale	25 ft (7.6 m)	'E' metric	6.00 lb (2.72 kg)	
98014	Height Scale	25 ft (7.6 m)	Philly metric	6.00 lb (2.72 kg)	
98015	Dual Scale	25 ft (7.6 m)	8ths / 10ths	6.00 lb (2.72 kg)	
98016	Dual Scale	25 ft (7.6 m)	10ths / Philly Metric	6.00 lb (2.72 kg)	
98017	Dual Scale	25 ft (7.6 m)	10ths / 10ths	6.00 lb (2.72 kg)	
98020	Height Scale	17 ft (5.18 m)	10ths	5.00 lb (2.27 kg)	
98021	Height Scale	17 ft (5.18 m)	8ths	5.00 lb (2.27 kg)	
98023	Height Scale	17 ft (5.18 m)	'E' metric	5.00 lb (2.27 kg)	
98024	Height Scale	17 ft (5.18 m)	Philly metric	5.00 lb (2.27 kg)	
98025	Dual Scale	17 ft (5.18 m)	8ths / 10ths	5.00 lb (2.27 kg)	
98026	Dual Scale	17 ft (5.18 m)	10ths / Philly metric	5.00 lb (2.27 kg)	

### Standard/Pro Series (LR) Leveling Rods

Round rod is wind resistant

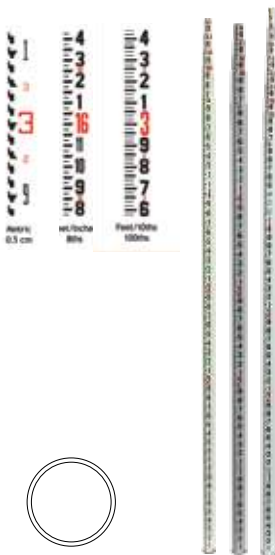

Round design makes the LR Series rods a good choice for certain applications like in areas of high wind.

#### FEATURES & BENEFITS

- ▶ The LR Series leveling rods are round and easy to handle
- ▶ The LR-STD is available in a 25 ft model in 10ths, inches, and 0.5 cm metric scales
- ▶ The LR-PRO is larger in diameter so sturdier and easier to read
- ▶ The LR-PRO is available in 25 ft, 35 ft and 45 ft lengths in feet/10ths/100ths

#### APPLICATIONS

- ▶ Grading
- ▶ Masonry
- ▶ Site work
- ▶ Forms
- ▶ Landscaping
- ▶ Foundations
- ▶ Sewers
- ▶ Slab work

Includes carrying case. Order 91402 for replacement carrying case – see page 68

PART NO.	LENGTH	OUTSIDE DIAMETER	GRADS	WEIGHS	
90004	LR-STD 25 ft	1-5/8 inch	10ths	5.00 lb (2.26 kg)	
90009	LR-STD 25 ft	1-5/8 inch	8ths	5.00 lb (2.26 kg)	
90014	LR-STD 7.6 m	1-5/8 inch	Metric	5.00 lb (2.26 kg)	
90022	LR-PRO 25 ft	2 inch	10ths	7.00 lb (3.17 kg)	
90024	LR-PRO 35 ft	2-3/16 inch	10ths	9.00 lb (4.08 kg)	
90026	LR-PRO 45 ft	2-3/16 inch	10ths	10.00 lb (4.53 kg)	

**Rectangular Series (CR)  
Leveling Rods**

Rounded back corners for better gripping



Rectangular shape allows for laser detectors to be mounted directly to the rod – no bracket required!

**FEATURES & BENEFITS**

- ▶ Features a rectangular shape with rounded back corners for better gripping
- ▶ Scale width is graduated to fill the entire face of the rod and measuring scale on the back side that allows for overall height readings

- ▶ For laser detector mounting with no special brackets required
- ▶ Made with strong fiberglass which is waterproof, corrosion-resistant and non-conductive
- ▶ Features 1/4 x 20 female adapter in the top section

**APPLICATIONS**

- ▶ Grading
- ▶ Masonry
- ▶ Site work
- ▶ Forms
- ▶ Landscaping
- ▶ Foundations
- ▶ Sewers
- ▶ Slab work

Includes carrying case. Order 91410 for 8 ft or 91411 for 13 - 20 ft replacement carrying case – see page 68

PART NO.	LENGTH	GRADS	WEIGHS	
92001	8 ft	10ths	3.00 lb (1.36 kg)	
92002	8 ft	8ths	3.00 lb (1.36 kg)	
92021	13 ft	10ths	5.00 lb (2.26 kg)	
92022	13 ft	8ths	5.00 lb (2.26 kg)	
92041	16 ft	10ths	6.00 lb (2.72 kg)	
92042	16 ft	8ths	6.00 lb (2.72 kg)	
92031	20 ft	10ths	7.00 lb (3.17 kg)	
92032	20 ft	8ths	7.00 lb (3.17 kg)	
92026	4.0 m	'E' metric	5.00 lb (2.26 kg)	
92027	4.0 m	0.5 cm metric	5.00 lb (2.26 kg)	
92046	5.0 m	'E' metric	6.00 lb (2.72 kg)	
92047	5.0 m	0.5 cm metric	6.00 lb (2.72 kg)	
92048	5.0 m	British 'E' metric	6.00 lb (2.72 kg)	
92043	5.0 m	Philly metric	6.00 lb (2.72 kg)	

**SubSurface® Handheld  
Magnetic Locators**

Built by the team with the most experience in the industry



**FEATURES & BENEFITS**

- ▶ Both models come with an industry exclusive 7 year warranty
- ▶ Choose the standard model or the LCD meter model
- ▶ Tube-through construction ensures strength and durability from the bottom tip to the handle

- ▶ Overall length: 38.75 in (98.4 cm)
- ▶ The system comes with a padded carrying bag and four alkaline 9-volt batteries — two to use and two spares
- ▶ Waterproof from bottom tip to LCD box
- ▶ Weighs 2.00 lb (0.91 kg)

**APPLICATIONS**

- ▶ Perfect for locating survey corner markers, PK and Mag Nails, valve and covers, steel and iron pipes, well casings, steel tanks, lost tools or even downed and buried fence lines



Hard-shell case is impact resistant ABS plastic construction (ML-1-050, sold separately)

- ML-1 — SubSurface Handheld Magnetic Locators Standard Model
- ML-1M — SubSurface Handheld Magnetic Locators With LCD Meter
- ML-1-050 — Hard Shell Case for Locators





### Heavy-Duty Pocket Tape

Light weight measuring tools for all situations



#### FEATURES & BENEFITS

- ▶ Rubberized black and high visibility yellow case
- ▶ Positive thumb lock and release action

- ▶ Lengths vary from 12 ft to 33 ft
- ▶ Tape made from epoxy paint coated steel

#### Applications

- ▶ General construction

PART NO.	LENGTH	WIDTH	GRADS	
4769-00	25 ft	1 inch (32 mm)	10ths	
4769-01	25 ft	1 inch (32 mm)	10ths / Metric	
4769-02	25 ft	1 inch (32 mm)	10ths / 8ths	
4769-03	33 ft	1 inch (32 mm)	10ths	
4769-04	33 ft	1 inch (32 mm)	10ths / 8ths	
4769-06	33 ft (10 m)	1 inch (32 mm)	10ths / Metric	
4769-14	5 m	3/4 inch (19 mm)	m/cm/mm	

### Coated Fiberglass and Steel Measuring Tapes

Great in all kinds of weather conditions



#### FEATURES & BENEFITS

- ▶ These coated tapes are designed to be used in the field for many years
- ▶ Single sided tape

- ▶ Choose between PVC-coated fiberglass or nylon-coated steel tape
- ▶ Features a hook end and fast-winding crank

#### APPLICATIONS

- ▶ General construction

PART NO.	TYPE	LENGTH	GRADS	
3003-06	PVC-Coated Fiberglass	100 ft	10ths	
3003-07	PVC-Coated Fiberglass	200 ft	10ths	
3003-10	PVC-Coated Fiberglass	30 m	m/cm/mm	
3003-14	PVC-Coated Fiberglass	90 m	m/cm/mm	
3006-06	Nylon-Coated Steel	100 ft	10ths	
3006-07	Nylon-Coated Steel	200 ft	10ths	
3006-10	Nylon-Coated Steel	30 m	m/cm/mm	
3006-11	Nylon-Coated Steel	60 m	m/cm/mm	
3006-18	Nylon-Coated Steel	200 ft/60 m	10ths / Metric (Dual Grad)	
3003-08	PVC-Coated Fiberglass	300 ft	10ths	

### Rhino Ruler® Engineer's Folding Ruler

Waterproof fiberglass outlasts wood rulers



#### FEATURES & BENEFITS

- ▶ Waterproof fiberglass construction prevents common problems that occur with wood rulers such as fading, splintering, and chipping

- ▶ Engraved graduations resist weather and scratches
- ▶ Easy-to-fold locking joints are tighter than traditional folding rulers made of wood allowing for a more accurate measurement along the ruler's length

#### APPLICATIONS

- ▶ General construction

4770-00 — Rhino Ruler Waterproof Fiberglass Engineer's Folding Ruler - 10ths / 8ths  
 4770-01 — Rhino Ruler Waterproof Fiberglass Engineer's Folding Ruler - 10ths / Metric



**CMR Series Measuring Rulers and Cases**

Designed for one-person measuring



**FEATURES & BENEFITS**

- ▶ A versatile tool for fast, accurate, one-person measuring, the CMR Series is the tool for measuring heights, clearances and horizontal distances up to fifty feet
- ▶ The rod is equipped with a female 1/4 x 20 adapter in the top section
- ▶ Made of rugged, non-conductive fiberglass and includes a carrying case and calliper tip
- ▶ Carrying cases are made from the highest quality 1000-denier nylon

PART NO.	LENGTH	WEIGHT	OD	REPLACEMENT CARRY CASE	OD CASE MEASUREMENTS	
90180	25 ft (7.6 m)	5.00 lb (2.27 kg)	1-13/16 inch	91415	3.5 x 65 in (8.89 x 165.1 cm)	
90181	36 ft (11 m)	9.00 lb (4.08 kg)	2-7/32 inch	91416	4.5 x 68 in (11.43 x 172.72 cm)	
90182	50 ft (15.2 m)	12.00 lb (5.44 kg)	2-13/32 inch	91417	4.5 x 76 in (11.43 x 193.04 cm)	

**Gopher Pole Wire Installation Tool**

Installing wires across ceiling spans is a lot easier with this unique fiberglass pole



**FEATURES & BENEFITS**

- ▶ With its long, adjustable span of up to 22 feet, the Gopher Pole makes wiring easy in hard-to-reach areas such as suspended ceilings, sub-rooms, crawl spaces and attics
- ▶ Ideal for pushing/pulling wire over long spans and acoustic ceiling tiles
- ▶ Telescopes from 4 to 22 feet (1.22 to 6.70 meters) in seconds
- ▶ Features a positive-locking system that won't accidentally collapse
- ▶ Features a strong but malleable metal tip that allows for easy shaping of the hook
- ▶ Sturdy and lightweight with no loose parts; constructed of durable non-conductive fiberglass
- ▶ Includes a carrying case

**APPLICATIONS**

- ▶ Utility Companies
- ▶ Electrical Contractors
- ▶ Electrical Supply Distributors
- ▶ Communications
- ▶ Data Network Solutions
- ▶ Commercial And Industrial Lighting
- ▶ Security Equipment Firms
- ▶ General Interior Construction



90520 — Gopher Pole Wire Installation Tool  
 91415 — Carrying Case



### Stream Gauges Plate Numbers

Sturdy fiberglass assures a long life, will not rust or corrode



#### FEATURES & BENEFITS

- ▶ Number plates may be used to customize elevations for a particular application

- ▶ All stream gauges are 1/8-inch thick and the pre-drilled holes for mounting have a diameter of 1/4-inch

#### APPLICATIONS

- ▶ Monitoring the water level of rivers, creeks, streams, bays etc.

PART NO.	NUMBER PLATE	MEASURES	
99060	0 (zero)	2-1/4 x 4 inches	
99061	1 (one)	2-1/4 x 4 inches	
99062	2 (two)	2-1/4 x 4 inches	
99063	3 (three)	2-1/4 x 4 inches	
99064	4 (four)	2-1/4 x 4 inches	
99065	5 (five)	2-1/4 x 4 inches	
99066	6 (six)	2-1/4 x 4 inches	
99067	7 (seven)	2-1/4 x 4 inches	
99068	8 (eight)	2-1/4 x 4 inches	
99069	9 (nine)	2-1/4 x 4 inches	
99070	- (Minus)	2-1/4 x 4 inches	

### Hand Levels

1X and 2X Magnification



4040-05



4040-60



4040-30



4200-00



4300-00

#### FEATURES & BENEFITS

- ▶ Features brass bodies, a non-glare internal finish, high-visibility neon yellow vials, and three-line mirrors
- ▶ The 1X model (4040-05), 5 inch (127 mm) hand level extends to 7 inches (178 mm) and has an external vial that is easily replaced in the field
- ▶ The 1X model, (4040-60) is an economically priced 5 inch (127 mm) hand level and has

an external vial that is easily replaced in the field

- ▶ The 2X model (4040-30) is a heavy-duty 5 inch (127 mm) hand level that extends to 7 inches (178 mm) and has an external vial that is easily replaced in the field
- ▶ 2X model (4300-00) is a heavy-duty, 5 inch (127 mm) hand level that extends to 7 inches (178 mm) and features an enclosed vial

- ▶ The 2X model (4200-00) is the industry standard 6 inch (152 mm) hand level that extends to 7 inches (178 mm) and has an enclosed vial

- ▶ Case included
- ▶ 4040-05 and 4040-60 weigh 0.30 lb (0.14 kg)
- ▶ 4040-30 weighs 0.35 lb (0.16 kg)
- ▶ 4200-00 and 4300-00 weigh 0.40 lb (0.18 kg)

4040-05 — 5 to 7 inch, 1X External Vial

4040-60 — 5 inch, 1X External Vial

4040-30 — 5 to 7 inch, 2X External Vial

4200-00 — 6 to 7 inch, 2X Internal Vial

4300-00 — 5 to 7 inch, 2X External Vial

- ▶ The Abney level is ideal for preliminary survey or landscaping, where the determination of slope, angle and percentage is required
- ▶ Measures 5.25 inches (133 mm) in length
- ▶ Weighs 0.15 lb (0.07 kg)



4050-01 — Abney Hand Level

- ▶ Made from padded Nylon Cordura is perfect for your level
- ▶ Measures 6.5 x 2.62 inches (16.5 x 6.66 cm)
- ▶ Weighs 0.05 lb (0.02 kg)

Replacement case for all hand levels shown above



8030-00-CABLU — Hand Level Case

Stream Gauges

Allows you to instantly see water levels

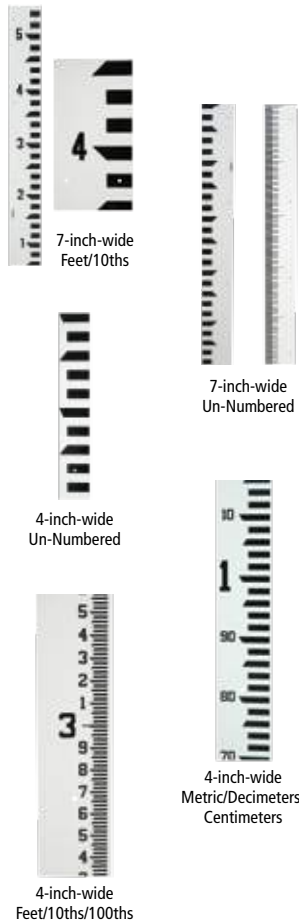

FEATURES & BENEFITS

- ▶ Stream Gauges allow you to instantly see water levels
- ▶ Fiberglass stream gauges are the best permanent marker in a variety of applications and environments
- ▶ Sturdy fiberglass assures a long life, it does not rot, rust or corrode
- ▶ Stream gauges are provided in separate units that can be used separately or combined for convenient measuring
- ▶ Easy to read at long distances, gauges are protected with a non-glare coating and are easy to mount

- ▶ Stainless steel fasteners are provided which will attach to most surfaces including metal, masonry, wood, and many other surface types
- ▶ 1/8 inch thick and the pre-drilled holes for mounting have a diameter of 1/4 inch
- ▶ Gauges may be ordered in successive increments to form ranges and elevations
- ▶ Number plates (sold separately) may be used to customize elevations for a particular application

APPLICATIONS

- ▶ Monitoring the water level of rivers, creeks, streams, bays etc.

7-inch Stream Gauges feature 2-1/4 inch (5.72 cm) tall numbers  
 4-inch Stream Gauges features 1-1/4-inch (3.175 cm) tall numbers  
 Use unnumbered gauges for height beyond 15.5 ft, 16 ft, or 3.66 m as needed

PART NO.	DESCRIPTION	LENGTH	WIDTH	GRADS	WEIGHS	
99000	Un-Numbered	4 ft	4 inch (10.2 cm)	feet / 10ths / 100ths	2.00 lb (0.91 kg)	
99001	4 ft	0 - 4 ft	4 inch (10.2 cm)	feet / 10ths / 100ths	2.00 lb (0.91 kg)	
99002	4 ft	4 - 8 ft	4 inch (10.2 cm)	feet / 10ths / 100ths	2.00 lb (0.91 kg)	
99003	4 ft	8 - 12 ft	4 inch (10.2 cm)	feet / 10ths / 100ths	2.00 lb (0.91 kg)	
99004	4 ft	12 - 16 ft	4 inch (10.2 cm)	feet / 10ths / 100ths	2.00 lb (0.91 kg)	
99023	Un-Numbered	4 ft	4 inch (10.2 cm)	feet / 10ths	2.00 lb (0.91 kg)	
99051	1.22 m	0 - 1.22 m	10.2 cm (4 inch)	m / dm / cm	2.00 lb (0.91 kg)	
99052	1.22 m	1.22 - 2.44 m	10.2 cm (4 inch)	m / dm / cm	2.00 lb (0.91 kg)	
99053	1.22 m	2.44 - 3.66 m	10.2 cm (4 inch)	m / dm / cm	2.00 lb (0.91 kg)	
99071	Un-Numbered	5 ft	7 inch (17.78 cm)	feet / 10ths / 100ths	4.00 lb (1.81 kg)	
99072	Un-Numbered	5 ft	7 inch (17.78 cm)	feet / 10ths	4.00 lb (1.81 kg)	
99079	5 ft	0.5 - 5.5 ft	7 inch (17.78 cm)	feet / 10ths	4.00 lb (1.81 kg)	
99080	5 ft	5.5 ft - 10.5 ft	7 inch (17.78 cm)	feet / 10ths	4.00 lb (1.81 kg)	
99081	5 ft	10.5 - 15.5 ft	7 inch (17.78 cm)	feet / 10ths	4.00 lb (1.81 kg)	



Mounting Hardware For Stream Gauges

Included with purchase of any Stream Gauge



FEATURES & BENEFITS

- ▶ Includes 7 sets of stainless steel screws and anchors
- ▶ Contains 14 each of screws and anchors packaged in packs of four

APPLICATIONS

- ▶ Monitoring the water level of rivers, creeks, streams, bays etc.

99043 — Mounting Hardware for Stream Gauges

### Magnetic Dampened Auto Level and Packages

Easy-to-use 24X and 32X auto-levels



#### FEATURES & BENEFITS

- ▶ The 32X auto level features a sturdy metal Japanese-style body with a magnetic dampened compensator
- ▶ Fits 5/8 x 11 flat or domed tripods
- ▶ The top cover plate is easily removed for adjustment
- ▶ Accurate to 1/16 inch per 100 feet (with good weather conditions)
- ▶ Includes carrying case
- ▶ Air dampened auto compensator
- ▶ Double-sided, continuous horizontal tangent drives
- ▶ Stadia lines for simple distance measurement
- ▶ Water resistant construction
- ▶ Convenient horizontal angle measurement
- ▶ Built in bubble mirror and optical sighting alignment
- ▶ Metal housing for increased durability
- ▶ Kit comes with 5301-25-BLK tripod; rod in kit may be inches or mm

#### APPLICATIONS

- ▶ Two-person leveling across the job site
- ▶ Leveling forms and footers
- ▶ Checking elevation
- ▶ Measuring cut and fill

PART NO.	POWER/DAMPENING	TRIPOD	ROD	
4811-24	24X / Magnetic Dampened	No	None	
4811-24P1	24X / Magnetic Dampened	Yes	9 ft, 8ths / feet	
4811-24P2	24X / Magnetic Dampened	Yes	9 ft, 10ths / feet	
4811-24P3	24X / Magnetic Dampened	Yes	3 m, Metric	
4811-24P4	24X / Magnetic Dampened	Yes	13 ft, 8ths / feet	
4811-24P5	24X / Magnetic Dampened	Yes	13 ft, 10ths / feet	
4811-24P6	24X / Magnetic Dampened	Yes	4 m, Metric	
4811-24P7	24X / Magnetic Dampened	Yes	16 ft, 8ths / feet	
4811-24P8	24X / Magnetic Dampened	Yes	16 ft, 10ths / feet	
4811-32	32X / Magnetic Dampened	No	None	
4811-32P1	32X / Magnetic Dampened	Yes	9 ft, 8ths / feet	
4811-32P2	32X / Magnetic Dampened	Yes	9 ft, 10ths / feet	
4811-32P3	32X / Magnetic Dampened	Yes	3 m, Metric	
4811-32P6	32X / Magnetic Dampened	Yes	4 m, Metric	

SPECIFICATIONS	4811-24	4811-32	AL24A	AL24M	AL32A
Magnification	24X	32X	24X	24X	32X
Objective Diameter	36 mm	42 mm	30 mm	30 mm	36 mm
Field of View Angle	1° 20'	1° 20'	1° 20'	1° 20'	1° 20'
Shortest Focusing Distance	0.3 m	0.3 m	0.6 m	0.6 m	0.6 m
Stadia Constant	100	100	100	100	100
Additive Constant	0	0	0	0	0
Compensator Dampening	Magnetic	Magnetic	Air	Magnetic	Air
Compensator Range	±15'	±15'	±15'	±15'	±15'
Compensator Setting Accuracy	<0.5"	<0.5"	<0.5"	<0.5"	<0.3"
Double Run Leveling per 1 km	2 mm	1 mm	2 mm	2 mm	1 mm
Circular Vial Accuracy	8/2 mm	8/2 mm	8/2 mm	8/2 mm	8/2 mm
Horizontal Circle	1°	1°	1°	1°	1°
Base Plate	5/8 x 11	5/8 x 11	5/8 x 11	5/8 x 11	5/8 x 11
Color	Red	Red	Yellow	Yellow	Yellow
Weight	3.97 lb (1.80 kg)	3.97 lb (1.80 kg)	3.50 lb (1.60 kg)	3.50 lb (1.60 kg)	3.50 lb (1.60 kg)

PART NO.	POWER/DAMPENING	TRIPOD	ROD	
AL24A	24X / Air Dampened	No	None	
AL24M	24X / Magnetic Dampened	No	None	
AL24M-2	24X / Magnetic Dampened	Yes	16 ft, inches	
AL32A	32X / Air Dampened	No	None	



## Construction Theodolite

Full-featured digital theodolite for construction



DE-50  
Optional eye piece sold  
separately

### FEATURES & BENEFITS

- ▶ Designed for general construction applications
- ▶ The Spectra Precision DET-2 digital electronic theodolite gives you accurate measurements in an affordable, versatile, easy to use platform
- ▶ Offers dual displays and controls for easy accessibility and operation, very large backlit LCD characters for easy reading (also, reduces eye strain and chance for errors), and a host of features and parameters normally found on much higher priced instruments
- ▶ Fast investment payback is the goal of the Spectra Precision DET-2
- ▶ With its 2-second accuracy (1- or 5-second selectable display readings) and vertical axis compensation, it can handle any construction job
- ▶ Operating costs are kept low with the included rechargeable battery pack and charger
- ▶ Able to be fully customized for your preferred operating style or job, with programmable settings for the horizontal angle resolution and beep, vertical degrees or %, automatic shutoff (to save battery life), and zenith angle

- ▶ A backup alkaline pack holding four standard AA batteries is also included
- ▶ Includes a built-in reticle illuminator that allows you to work inside buildings and other environments with little or no light, such as near dawn or dusk
- ▶ You can count on working in difficult conditions with an environmental rating of IP-54 making it water and dust-proof
- ▶ Comes equipped with a plumb bob, NiMH rechargeable battery pack and charger, alkaline battery pack, adjustment tools, rain hood, multi-language user guide, and hard-shell carrying case
- ▶ Accurate enough for any job, yet the display resolution can be tailored to any operator's preferences for fast readings
- ▶ Vertical axis compensation can be turned on or off depending on the operator or job
- ▶ Programmable settings for the horizontal angle resolution and beep, vertical degrees or percent are easy to configure
- ▶ The recharge kit reduces operating costs and downtime
- ▶ For Specifications see website

### APPLICATIONS

- ▶ Establishing 90 degree reference lines
- ▶ Checking angles, alignment, and plumb
- ▶ Anchor bolt alignment
- ▶ Gravity flow pipe laser setup
- ▶ Steel column placement
- ▶ Alignment of forms, tilt-up walls, and curtain walls
- ▶ Basic grade work
- ▶ Short range leveling

DET-2 — Construction Theodolite  
DE-50 — Diagonal Eye Piece



## Batter Board Clamp

Accessories and components for rotating lasers



### FEATURES & BENEFITS

- ▶ Attaches to boards with thicknesses up to 2.17 in (55 mm)
- ▶ Mounting plate with its 5/8 x 11 screw can easily be removed when connecting it to a laser or theodolite
- ▶ Nail hole ensures that a theodolite's axis is positioned exactly over the reference point
- ▶ Soft-touch locking knobs prove comfortable when using in cold and wet weather
- ▶ 3-point contact for secure, sturdy grip
- ▶ Quick release clamp for quick instrument attachment
- ▶ Weighs 2.43 lb (1.10 kg)

### APPLICATIONS

- ▶ Perfect for a laser for vertical applications or Theodolites

4852-14 — Batter Board Clamp 

## Lightning 2 Laser Detector

Lets you get to grade faster on a wide variety of job sites





### FEATURES & BENEFITS

- ▶ The Lightning™ 2 has an easy-to-read dual LCD and LED displays
- ▶ Comes equipped with a snap-in rod clamp allowing for fast switching from rod-mounted to hand-held applications
- ▶ Tough IP67 waterproof housing protects the unit from dust, moisture, and accidental drops
- ▶ Loud 100 db speaker can be heard on noisy job sites
- ▶ With two on-grade sensitivities (fine and medium), the Lightning 2 lets you get to grade faster on a wide variety of job sites
- ▶ Weighs (with batteries) 0.65 lb (0.29 kg)
- ▶ Weighs (without batteries and rod clamp) 1.00 lb (0.45 kg)

### APPLICATIONS

- ▶ Highly accurate distance measurement

ATI993600-02 — Lightning 2 Laser Detector – Red   
ATI993600-09 — Lightning 2 Laser Detector – Yellow 

## Storm Laserometer Receiver

Highly-visible LED lights show red for off-grade and green for on-grade



### FEATURES & BENEFITS

- ▶ Features a digital readout of elevation which provides a numeric display of  $\pm 2$  inches ( $\pm 5$  cm)
- ▶ Accurate measurements can be made without moving the rod clamp, saving time and increasing productivity
- ▶ Waterproofed to IP67 standards
- ▶ The protective over-molding allows it to withstand a drop of 10 feet (3 meters) onto concrete
- ▶ The patented universal reversible clamp fits square and oval rods
- ▶ 5 inch (12.7 cm) reception height, allows quick acquisition of the laser beam
- ▶ A patented anti-strobe sensor prevents construction lights from giving faulty signals
- ▶ The high visible LEDs on the front show red for high and low and green for on-grade
- ▶ Fiberglass rod sold separately
- ▶ Weighs (with batteries) 0.85 lb (0.38 kg)
- ▶ Weighs (without batteries and rod clamp) 1.20 lb (0.54 kg)

### APPLICATIONS

- ▶ Highly accurate distance measurement

ATI994000-02 — Storm Laserometer Receiver - Red   
ATI994000-09 — Storm Laserometer Receiver - Yellow 

## Twister Laser Receiver

Specifically designed for harsh, loud construction environments



### FEATURES & BENEFITS

- ▶ Designed to receive reference elevation information from rotating laser levels
- ▶ Detector receives invisible laser beams as well as visible red beams
- ▶ Detector includes a Liquid Crystal Display (LCD) on the front and rear for easy indication of detector status and grade information
- ▶ Beeper emits an audible tone that indicates on-grade, high or low
- ▶ Specifically designed for use in harsh, loud construction environments
- ▶ Battery life is 70+ hours
- ▶ Beam window height is 2 inches
- ▶ Accuracy levels are user selectable to meet various job requirements
- ▶ Impact resistant housings, recessed windows, waterproof design, durable battery

- contacts, and a high volume beeper are incorporated into every detector
- ▶ General purpose clamp is designed to mount the detector on various grade rods and staffs
- ▶ Weighs 1.00 lb (0.45 kg) with batteries

### APPLICATIONS

- ▶ Highly accurate distance measurement

ATI993640-09 — Twister Laser Receiver - Yellow 

**Bullseye 6 Laser Receiver**

Four selectable accuracies for each on-grade location



**FEATURES & BENEFITS**

- ▶ Angle compensation automatically calculates and corrects grade display for the angle of the dipper arm
- ▶ Check grade with the dipper arm extended or retracted up to 30°

- ▶ Plumb indication built in – for quick and accurate grade checking for excavators and backhoes
- ▶ Offset on-grade – for productive excavation
- ▶ Center On-grade – for grading operations – use on dozers,

- graders, scrapers, box blades
- ▶ Up to 8 channels of grade information plus directional out of beam indicators

**APPLICATIONS**

- ▶ Highly accurate distance measurement

PART NO.	POWER SOURCE	COLOR	
ATI991320-02	Alkaline	Red	
ATI991320-09	Alkaline	Yellow	
ATI991326-02	Rechargeable NIMH	Red	
ATI991326-09	Rechargeable NIMH	Yellow	

**Bullseye 5+ Laser Receiver**

Four selectable accuracies for each on-grade location



**FEATURES & BENEFITS**

- ▶ Angle compensation automatically calculates and corrects grade display for the angle of the dipper arm
- ▶ Check grade with the dipper arm extended or retracted up to 30°

- ▶ Plumb indication built in – for quick and accurate grade checking for excavators and backhoes
- ▶ Offset on-grade – for productive excavation
- ▶ Center On-grade – for grading operations – use on dozers,

- graders, scrapers, box blades
- ▶ Up to 8 channels of grade information plus directional out of beam indicators

**APPLICATIONS**

- ▶ Highly accurate distance measurement

PART NO.	POWER SOURCE	COLOR	
ATI991370-02	Alkaline	Red	
ATI991370-09	Alkaline	Yellow	
ATI991376-02	Rechargeable NIMH	Red	
ATI991376-09	Rechargeable NIMH	Yellow	

**Bullseye 3+ Laser Receiver**

Use on dozers, graders, scrapers, and box blades



**FEATURES & BENEFITS**

- ▶ Adapts to grading and excavating machinery
- ▶ Easy to move from one machine to another
- ▶ 3 selectable accuracies - work from rough grading to final finishing

- ▶ Bright LED's with green on-grade
- ▶ 5 channels of grade information plus directional out of beam indicators

**APPLICATIONS**

- ▶ Highly accurate distance measurement

PART NO.	POWER SOURCE	COLOR	
ATI991340-02	Alkaline	Red	
ATI991340-09	Alkaline	Yellow	
ATI991346-02	Rechargeable NIMH	Red	
ATI991346-09	Rechargeable NIMH	Yellow	

### Bullseye Magnetic Mounts

Use with Bullseye Receivers



#### FEATURES & BENEFITS

- ▶ Both magnetic mount models can be used with all Bullseye receivers
- ▶ Two magnet banks combine for 900 pounds of holding force

- ▶ Easy to slide receiver up and down
- ▶ Easy removal is accomplished using a release lever
- ▶ Features a large vertical adjustment range for quicker laser set-ups

#### APPLICATIONS

- ▶ Highly accurate distance measurement

ATI991360-02 — Bullseye Magnetic Mount - For Backhoe and Excavator



ATI991364-02 — Bullseye Magnetic Mount - For Flat Back Dozer Blades



### Bullseye Receiver Accessories

#### PART NO.

#### BULLSEYE RECEIVER ACCESSORIES

ATI010972-50

Receiver cable, straight, 50 ft



ATI010983

Machine power cable, lighter adapter, 2-8 ft



ATI991604

Universal battery charger with wall plugs



### Rebar Bolts



#### FEATURES & BENEFITS

- ▶ Measures 3/4 x 9.9 inches (19.05 x 251.46 mm) long
- ▶ Includes a hex bolt used to

- hammer the bolt in to the surface
- ▶ Once installed, remove the hex bolt and install the 6601-Series

- adapter of your choice
- ▶ Choose between 3/8 x 16, M8 or M12 thread patterns
- ▶ Weighs 1.25 lb (0.57 kg)

6602-01 — Rebar Bolt 3/8 x 16 Threads



6602-02 — Rebar Bolt M12 Threads



6602-03 — Rebar Bolt M8 Threads



Monitoring Accessories

Aluminum plates for anchoring

- ▶ Wedge-shaped aluminum plate features a 12.5 mm prism
- ▶ Plate can be fixed with special adhesive on to the pavement
- ▶ Dimensions: 10 x 10 x 2 cm (3.94 x 3.94 x 0.79 inches)
- ▶ Weighs 0.62 lb (0.28 kg)



4 520 800 — 12.5 mm Street-Mountable Building Monitoring Prism System

- ▶ Anodized aluminum plate
- ▶ Three key holes for screws to mount the plate
- ▶ With 5/8 x 11 threaded stud for Tribrach adapter centered on the plate
- ▶ Weighs 1.81 lb (0.82 kg)

See Drawing for Installation Data

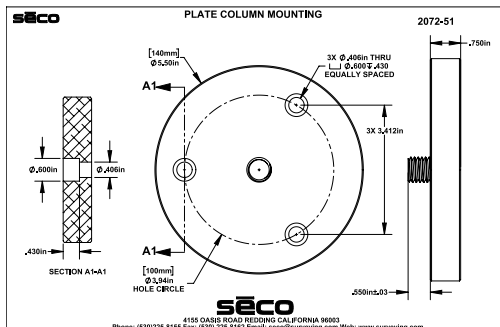

2072-51 — Screw Mounting Column Plate

- ▶ Anodized aluminum plate
- ▶ The three bottom anchor bolts are embedded in concrete during installation
- ▶ With 5/8 x 11 threaded stud for Tribrach adapter centered on the plate
- ▶ Weighs 2.29 lb (1.04 kg)

See Drawing for Installation Data

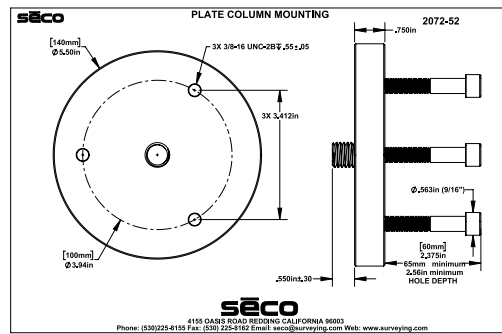

2072-52 — Column Plate

Wall/Column Bracket for Lasers and Total Stations

Dual mounting options enable flexibility on the construction job site



FEATURES & BENEFITS

- ▶ SECO's 4852-17 is a dual-use bracket for lasers and total stations
- ▶ Mounts easily to columns (or corners) and flat walls
- ▶ The unique design allows quick and easy separation for dual usage

- ▶ 5/8 x 11 platform holds the instrument 5 inches from the wall/column surface
- ▶ A ratchet and strap secures the bracket to columns up to 20 inches (use Extension Strap #D12328 for larger columns, offering 37 to 69 inches of extra length)

- ▶ Multiple nail/screw holes enable wall mounting
- ▶ Features a powder coated steel frame
- ▶ Weighs 5.00 lb (2.30 kg)

APPLICATIONS

- ▶ For use with Lasers and Total Stations on large construction sites

4852-17 — Wall/Column Bracket for Lasers and Total Stations

Wall Mount Bracket

Simple and secure set-up for any ferrous metal surfaces



FEATURES & BENEFITS

- ▶ Strong one-piece construction
- ▶ Designed to hold U-Bolts for 2- or 3-inch (50.8- or 7.62-cm) diameter pipe

- ▶ 4 x 0.69-inch (10.16 x 1.75-cm) wall mounting holes on 6-inch (15.24 cm) centers\*
- ▶ 8-inch (203-mm) stand off from flat wall surface

- ▶ Welded 1/2-inch (6.35-mm) steel
- ▶ Powder painted wrinkle black
- ▶ Weighs 9.15 lb (4.20 kg)

2072-60 — Wall Mount Bracket

\*Installation hardware not included



### Heavy Duty Instrument Column Clamp

Mounts to structural columns for stability and support for heavy instruments



#### FEATURES & BENEFITS

- ▶ SECO's Heavy Duty Column Clamp has a solid stable design and works with all 5/8 x 11 instruments
- ▶ The adjustable column rotates and moves vertically to orient the instrument when needed and features 12 inches (30.48 cm) of height adjustment
- ▶ Now with 0.39" holes in each corner for hard mounting with
  - 3/8 bolts ( not supplied )
- ▶ Centerline of the 5.8 x 11 stud to column measures 15 inches (38.1 cm)
- ▶ Includes 20 inch standard 3/4 inch NPT Pipe with Heavy Duty sliding clamp
- ▶ Constructed of structural aluminum for industrial applications and stainless steel hardware
- ▶ Weight is 15 lbs (6.8 kg)

#### APPLICATIONS

- ▶ For use with Robotic Total Stations and scanners
- ▶ Ideal for mounting theodolites, lasers, etc.

4852-18 — Heavy Duty Instrument Column Clamp 

Order 2"X10 ft ratchet strap kit 4852-18-050 as needed for different mounting options

### Heavy-Duty Instrument Column Clamp

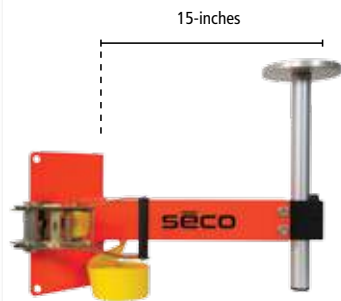

#### FEATURES & BENEFITS

- ▶ SECO's Heavy-Duty Column Clamp has a solid stable design and works with all 5/8 x 11 instruments
- ▶ The adjustable column rotates and moves vertically to orient the instrument when needed and features 12-inches (30.48 cm) of height adjustment
- ▶ Centerline of the 5/8 x 11 stud to column measures 15-inches (38.1-cm)
- ▶ Now with 0.39" holes in each corner for hard mounting with 3/8 bolts ( not supplied )
- ▶ Includes a 2-inch (5.08 cm) by 10-ft (3.05-m) strap rated for a 2200 pound load and a heavy-duty ratchet to create a strong connection to both round and square columns
- ▶ Constructed of structural aluminum for industrial applications and stainless steel hardware
- ▶ Weighs 13.75 lb (6.24 kg)

#### APPLICATIONS

- ▶ For use with Robotic Total Stations and scanners
- ▶ Ideal for mounting theodolites, lasers, etc.

4852-16 — Heavy-Duty Column Clamp 

### Rotating Laser Column Clamp

Accessories and components for rotating lasers



#### FEATURES & BENEFITS

- ▶ Works with all 5/8 x 11 instruments
- ▶ Column rotates to orientate the instrument when needed and features 1 ft (30 cm) of height adjustment
- ▶ Center-line of the 5/8 x 11 stud to column measures 6.5 in (16.5 cm)
- ▶ Designed to fit both round and square columns
- ▶ A ratchet strap quickly tightens the column clamp into place to create a strong connection to columns with diameters up to 20 inches (0.5 m)
- ▶ Made of aluminum and stainless steel
- ▶ An Extension Strap is also available (D12328, sold separately) which adds 37 to 69 in (94 to 175.2 cm) to the existing strap for big columns
- ▶ Weighs 5.10 lb (2.32 kg)

#### APPLICATIONS

- ▶ Perfect for lasers or Theodolites

4852-15 — Column Clamp 

### Safety Utility Vest 8365-Series

Designed to meet ANSI/ISEA Class 3 Standards



#### FEATURES & BENEFITS















- ▶ Made from durable ANSI/ISEA compliant polyester and polyester mesh
- ▶ Features include YKK™ zippers, 4 inch (10.16 cm) wide reflective tape with 2 inch (50.8 mm) wide silver stripes made with 3M Scotchlite® reflective material
- ▶ Adaptive Comfort® material

- by Outlast®, a Certified Space Technology™, designed to balance body temperature
- ▶ Developed in conjunction with surveyors from the California Department of Transportation
- ▶ Includes many quality features; multiple pockets for cell phone, tapes, radio, pencils, maps, spray cans and etc

- ▶ Plus, two inside pockets and comes with dual mic clips

#### APPLICATIONS

- ▶ Workplace safety
- ▶ Perfect for construction crews or surveyors near busy roads or other possibly hazardous locations where worker visibility is desired

PART NO.	COLOR	SIZE	
8365-42-FLY	Fluorescent Yellow	42 (S)	
8365-42-FOR	Fluorescent Orange	42 (S)	
8365-46-FLY	Fluorescent Yellow	46 (M)	
8365-46-FOR	Fluorescent Orange	46 (M)	
8365-50-FLY	Fluorescent Yellow	50 (L)	
8365-50-FOR	Fluorescent Orange	50 (L)	
8365-54-FLY	Fluorescent Yellow	54 (XL)	
8365-54-FOR	Fluorescent Orange	54 (XL)	
8365-58-FLY	Fluorescent Yellow	58 (XXL)	
8365-58-FOR	Fluorescent Orange	58 (XXL)	
8365-62-FLY	Fluorescent Yellow	62 (XXXL)	
8365-62-FOR	Fluorescent Orange	62 (XXXL)	
8365-66-FLY	Fluorescent Yellow	66 (J)	
8365-66-FOR	Fluorescent Orange	66 (J)	

### Safety Utility Vest 8265-Series

Designed to meet ANSI/ISEA Class 2 Standards



#### FEATURES & BENEFITS















- ▶ Developed in conjunction with surveyors from the California DOT
- ▶ Features include bright fluorescent material, 4 inch (101.6 mm) wide contrasting reflective material with 2 inch (50.8 mm) wide silver stripes made of 3M™ Scotchlite™ reflective material

- ▶ Made of durable polyester, brass grommets, heavy-duty webbing and trim, and a genuine YKK™ zipper
- ▶ Adaptive Comfort® material by Outlast®, a Certified Space Technology™, designed to balance body temperature
- ▶ Features four large pockets on the outside and two generous pockets on the inside – great

- for field books, tapes, pencils, flagging, cell phones, etc
- ▶ Includes two spray can holders

#### APPLICATIONS

- ▶ Workplace Safety
- ▶ Perfect for construction crews or surveyors near busy roads or other possibly hazardous locations where worker visibility is desired

PART NO.	COLOR	SIZE	
8265-42-FLY	Fluorescent Yellow	42 (S)	
8265-42-FOR	Fluorescent Orange	42 (S)	
8265-46-FLY	Fluorescent Yellow	46 (M)	
8265-46-FOR	Fluorescent Orange	46 (M)	
8265-50-FLY	Fluorescent Yellow	50 (L)	
8265-50-FOR	Fluorescent Orange	50 (L)	
8265-54-FLY	Fluorescent Yellow	54 (XL)	
8265-54-FOR	Fluorescent Orange	54 (XL)	
8265-58-FLY	Fluorescent Yellow	58 (XXL)	
8265-58-FOR	Fluorescent Orange	58 (XXL)	
8265-62-FLY	Fluorescent Yellow	62 (XXXL)	
8265-62-FOR	Fluorescent Orange	62 (XXXL)	
8265-66-FLY	Fluorescent Yellow	66 (J)	
8265-66-FOR	Fluorescent Orange	66 (J)	

## Dual Safety Utility Vest 8260-Series U.S./Canada

Designed to meet ANSI/ISEA Class 2 and Canadian CSA-Z96 Standards



### FEATURES & BENEFITS

- ▶ Manufactured to meet ANSI/ISEA 107-2010 Class 2 and CSA-Z96 standards
- ▶ Vest compartments include a field notebook pocket, pencil slots, flagging tape pocket with grommets, and an internal cell phone pocket
- ▶ Includes a special padded collar made of Outlast® material for added comfort

- ▶ Four-inch-wide reflective tape that includes a two-inch-wide silver stripe and high-vis material makes this vest highly visible in any weather condition — day or night
- ▶ Also including two exterior radio mic clips and a front closing zipper
- ▶ Made of 100% polyester

### APPLICATIONS

- ▶ Workplace Safety
- ▶ Perfect for construction crews or surveyors near busy roads or other possibly hazardous locations where worker visibility is desired

PART NO.	COLOR	SIZE	
8260-46-FLY	Fluorescent Yellow	46 (M)	
8260-46-FOR	Fluorescent Orange	46 (M)	
8260-50-FLY	Fluorescent Yellow	50 (L)	
8260-50-FOR	Fluorescent Orange	50 (L)	
8260-54-FLY	Fluorescent Yellow	54 (XL)	
8260-54-FOR	Fluorescent Orange	54 (XL)	
8260-58-FLY	Fluorescent Yellow	58 (XXL)	
8260-58-FOR	Fluorescent Orange	58 (XXL)	
8260-62-FLY	Fluorescent Yellow	62 (XXXL)	
8260-62-FOR	Fluorescent Orange	62 (XXXL)	
8260-66-FLY	Fluorescent Yellow	66 (J)	
8260-66-FOR	Fluorescent Orange	66 (J)	

## Safety Utility Vest 8261-Series

Designed to meet EN 20471:2014 Class 2 Standards



### FEATURES & BENEFITS

- ▶ Features durable ISO 20471 compliant polyester and polyester mesh. This vest has heavy-duty YKK® zippers
- ▶ Features zipper openings on the side to allow for ventilation

- ▶ The padded collar is made with Outlast® fabric on the inside to help regulate body temperature
- ▶ 10.16 cm wide reflective tape with 5.08 cm wide silver stripes
- ▶ Vest is third-party CE certified
- ▶ Comes with an easy-to-access mic clip

- ▶ This vest has multiple pockets that are secure and easily accessible
- ▶ Chest sizes range from 96.52-167.64 cm (46" - 66")
- ▶ Sizes available: M, L, XL, 2X, 3X, J
- ▶ Available in fluorescent orange or fluorescent yellow

PART NO.	COLOR	SIZE	
8261-M-FLY	Fluorescent Yellow	116.84 cm (M)	
8261-M-FOR	Fluorescent Orange	116.84 cm (M)	
8261-L-FLY	Fluorescent Yellow	127 cm (L)	
8261-L-FOR	Fluorescent Orange	127 cm (L)	
8261-XL-FLY	Fluorescent Yellow	137.16 cm (XL)	
8261-XL-FOR	Fluorescent Orange	137.16 cm (XL)	
8261-XXL-FLY	Fluorescent Yellow	147.32 cm (XXL)	
8261-XXL-FOR	Fluorescent Orange	147.32 cm (XXL)	
8261-XXXL-FLY	Fluorescent Yellow	157.48 cm (XXXL)	
8261-XXXL-FOR	Fluorescent Orange	157.48 cm (XXXL)	
8261-J-FLY	Fluorescent Yellow	167.64 cm (J)	
8261-J-FOR	Fluorescent Orange	167.64 cm (J)	

### Economy Safety Vest 8290-Series

Designed to meet ANSI/ISEA Class 2 Standards











#### FEATURES & BENEFITS

- ▶ Manufactured to meet ANSI/ISEA Class 2 standards
- ▶ Manufactured with tricot and texturized polyester mesh for durability and comfort
- ▶ Made with 3M™ Scotchlite™ Reflective Material and a zipper on chest for frontal closure

- ▶ Stays cool in the summer heat and is visible in low-light conditions
- ▶ Features a wide variety of pockets including: radio pocket; pencil pocket; two front outside pockets; two front inside pockets and a rear map pocket
- ▶ Weighs 0.71 lb (0.32 kg)

#### APPLICATIONS

- ▶ Workplace Safety
- ▶ Perfect for construction crews or surveyors near busy roads or other possibly hazardous locations where worker visibility is desired

PART NO.	COLOR	SIZE	
8290-50-FLY	Fluorescent Yellow	50 (L)	
8290-50-FOR	Fluorescent Orange	50 (L)	
8290-54-FLY	Fluorescent Yellow	54 (XL)	
8290-54-FOR	Fluorescent Orange	54 (XL)	
8290-58-FLY	Fluorescent Yellow	58 (XXL)	
8290-58-FOR	Fluorescent Orange	58 (XXL)	
8290-62-FLY	Fluorescent Yellow	62 (XXXL)	
8290-62-FOR	Fluorescent Orange	62 (XXXL)	

### Safety Utility Vest 8068-Series

Designed to meet ANSI/ISEA Class 2 Standards

















#### FEATURES & BENEFITS

- ▶ Durable fluorescent fabric is constructed of 100% polyester for softness, comfort, superior strength and abrasion resistance
- ▶ Features convenient pockets with sturdy fasteners, map pocket and mic clip

- ▶ Complies with ANSI/ISEA Class 2 standards for high-visibility safety apparel with two-inch-wide stripes of retroreflective tape
- ▶ Snaps on chest allow vest to close

#### APPLICATIONS

- ▶ Workplace Safety
- ▶ Perfect for construction crews or surveyors near busy roads or other possibly hazardous locations where worker visibility is desired

PART NO.	COLOR	SIZE	
8068-42-FLY	Fluorescent Yellow	42 (S)	
8068-42-FOR	Fluorescent Orange	42 (S)	
8068-46-FLY	Fluorescent Yellow	46 (M)	
8068-46-FOR	Fluorescent Orange	46 (M)	
8068-50-FLY	Fluorescent Yellow	50 (L)	
8068-50-FOR	Fluorescent Orange	50 (L)	
8068-54-FLY	Fluorescent Yellow	54 (XL)	
8068-54-FOR	Fluorescent Orange	54 (XL)	
8068-58-FLY	Fluorescent Yellow	58 (XXL)	
8068-58-FOR	Fluorescent Orange	58 (XXL)	
8068-62-FLY	Fluorescent Yellow	62 (XXXL)	
8068-62-FOR	Fluorescent Orange	62 (XXXL)	
8068-66-FLY	Fluorescent Yellow	66 (J)	
8068-66-FOR	Fluorescent Orange	66 (J)	



## Surveyors Utility Vest 8063-Series

Designed to meet ANSI/ISEA Class 2 Standards



### FEATURES & BENEFITS

- ▶ Vests are manufactured to meet ANSI/ISEA Class 2 standards
- ▶ Features a comfortable hi-tech liner made of Adaptive Comfort® material by Outlast®, a Certified Space Technology™, designed to balance body

- ▶ temperature
- ▶ 100% polyester
- ▶ Snap closure
- ▶ Includes pockets for notebooks, maps, pencils, compasses, flagging tape, etc
- ▶ Also features exterior radio mic clip
- ▶ Weighs 1.94 lb (0.89 kg)

### APPLICATIONS

- ▶ Workplace Safety
- ▶ Perfect for construction crews or surveyors near busy roads or other possibly hazardous locations where worker visibility is desired

PART NO.	COLOR	SIZE	
8063-42-FLY	Fluorescent Yellow	42 (S)	
8063-42-FOR	Fluorescent Orange	42 (S)	
8063-46-FLY	Fluorescent Yellow	46 (M)	
8063-46-FOR	Fluorescent Orange	46 (M)	
8063-50-FLY	Fluorescent Yellow	50 (L)	
8063-50-FOR	Fluorescent Orange	50 (L)	
8063-54-FLY	Fluorescent Yellow	54 (XL)	
8063-54-FOR	Fluorescent Orange	54 (XL)	
8063-58-FLY	Fluorescent Yellow	58 (XXL)	
8063-58-FOR	Fluorescent Orange	58 (XXL)	
8063-62-FLY	Fluorescent Yellow	62 (XXXL)	
8063-62-FOR	Fluorescent Orange	62 (XXXL)	
8063-66-FLY	Fluorescent Yellow	66 (J)	
8063-66-FOR	Fluorescent Orange	66 (J)	

## Safety Utility Vest 8069-Series

Designed to meet ANSI/ISEA Class 2 Standards



### FEATURES & BENEFITS

- ▶ Vests are manufactured to meet ANSI/ISEA Class 2 standards
- ▶ Features a cool, comfortable mesh back and snaps in front to close vest

- ▶ 100% polyester
- ▶ Includes special compartments for notebooks, pencils, compass, flagging tape, etc
- ▶ Features exterior radio mic clip

### APPLICATIONS

- ▶ Workplace Safety
- ▶ Perfect for construction crews or surveyors near busy roads or other possibly hazardous locations where worker visibility is desired

PART NO.	COLOR	SIZE	
8069-42-FLY	Fluorescent Yellow	42 (S)	
8069-42-FOR	Fluorescent Orange	42 (S)	
8069-46-FLY	Fluorescent Yellow	46 (M)	
8069-46-FOR	Fluorescent Orange	46 (M)	
8069-50-FLY	Fluorescent Yellow	50 (L)	
8069-50-FOR	Fluorescent Orange	50 (L)	
8069-54-FLY	Fluorescent Yellow	54 (XL)	
8069-54-FOR	Fluorescent Orange	54 (XL)	
8069-58-FLY	Fluorescent Yellow	58 (XXL)	
8069-58-FOR	Fluorescent Orange	58 (XXL)	
8069-62-FLY	Fluorescent Yellow	62 (XXXL)	
8069-62-FOR	Fluorescent Orange	62 (XXXL)	
8069-66-FLY	Fluorescent Yellow	66 (J)	
8069-66-FOR	Fluorescent Orange	66 (J)	



## Hydration Backpack

Stay hydrated on the job while maintaining workplace safety



### FEATURES & BENEFITS

- ▶ 20 x 8 inches (50.8 x 20.32 cm)
- ▶ Chest strap with side release buckle
- ▶ 4-inch (101.6 mm) wide fabric with 2-inch (50.8 mm) wide reflective tape (same as safety vest)
- ▶ 1-inch (25.4 mm) wide polypropylene webbing allows shoulder straps to adjust
- ▶ 1000D Cordura Nylon is bonded to the 1/4-inch (6.35 mm) back padding
- ▶ Neoprene sleeve surrounds the hydration tube

- ▶ Bladder size 2.5 liters (84.5 fl oz)
- ▶ When bladder is completely full the hydration pack is 5 inches (127 mm) thick
- ▶ Mod-U-Lox® keeps hydration tube secure on either strap, allowing access to the bite valve for either right- or left-handed use (one on each side)
- ▶ Weighs (with water) 6.70 lb (3.03 kg)
- ▶ Weighs (without water) 1.20 lb (0.54 kg)

### Applications

- ▶ Workplace Safety
- ▶ Construction environment

8125-60-FOR — Hydration Backpack 



### Utility Bags and Miscellaneous Cases

Designed to keep your field equipment and supplies safe and secure

- ▶ Features four exterior deep-zippered pockets — two front and two side
- ▶ Two interior pockets — 14 x 12 x 2 inches with hook-and-loop closures
- ▶ Heavy-duty nylon webbing carrying straps
- ▶ Measures 30 x 14 x 20 inches (76.2 x 35.6 x 50.8 cm)
- ▶ Weighs 3.78 lb (1.72 kg)



8106-10-ORG — Monster Gear Bag

- ▶ Excellent for carrying surveying accessories, clothing, and other miscellaneous gear
- ▶ Made of heavy-duty water resistant polyester
- ▶ Measures 27 x 11 x 11 inches (69 x 28 x 28 cm)
- ▶ Weighs 1.56 lb (0.71 kg)



8106-20-ORG — Surveyor's Gear Bag with Rhinotek Bottom

- ▶ Fits most large controllers like the Ranger™ series, Allegro, TSC3™
- ▶ Features a Velcro® flap closure, belt loop and shoulder strap
- ▶ Main compartment measures 10.25 x 5.25 x 2 inches (26 x 13.3 x 5 cm)
- ▶ Padded with 0.25 in (6.35 mm) 1000D Cordura material with khaki trim
- ▶ Outside pocket is 6 x 5 in (15 x 12.7 cm)
- ▶ Weighs 0.35 lb (0.16 kg)



8142-01-ORG — Large Controllers Case

- ▶ Features include an outside pocket with a Velcro closure and 2 inch straps made with heavy-duty webbing
- ▶ Also features a Rhinotek™ and leather reinforced bottom
- ▶ Measures 10.25 x 15 inches (26 x 38 cm)
- ▶ Weighs 1.30 lb (0.59 kg)



8095-20-ORG — Heavy-Duty Collapsible Bucket Bag

- ▶ This case holds the Trimble® Pathfinder® ProXH™ or the ProXT™ GNSS unit securely
- ▶ Weighs 0.45 lb (0.20 kg)



8143-21-YEL — Trimble Pathfinder Series Pole Case

- ▶ Secure your cell phone to any survey pole without slipping
- ▶ Inside dimensions: 5 x 2.5 x 1.5 inches (12.7 x 6.35 x 3.81 cm)
- ▶ Weighs 0.10 lb (0.45 kg)



8143-22-FLY — GNSS Rod Cell Phone Case

- ▶ The MiFi Hotspot Case secures any MiFi unit to any GNSS survey pole or prism pole
- ▶ Easily attaches to a GNSS or prism pole with the metal clamp on case
- ▶ This pouch stays in place; it will not slip down the pole
- ▶ Features a window to clearly view the installed unit activity
- ▶ Works with all MiFi Hotspots and most smart phones on the market today
- ▶ A Velcro strap keeps unit safely inside clear pouch
- ▶ Inside dimensions 6 x 4.25 inches (15.24 x 10.8 cm)
- ▶ Constructed of heavy-duty Cordura®
- ▶ Comes in fluorescent yellow
- ▶ Weighs 0.35 lb (0.16 kg)



8143-40-FLY — MiFi Hotspot Case

### Tool Pouches

Designed to keep your tools safe and organized

- ▶ Features include an 11 x 7 inch (28 x 18 cm) and 6 x 4 inch (15 x 10 cm) pouches
- ▶ Has slots for markers, a loop for axes or hammers
- ▶ Weighs 0.40 lb (0.18 kg)



8046-20-ORG — Construction-Style Tool Pouch

- ▶ Features a 9 x 2 x 11 inch (22.9 x 5.08 x 27.9 cm) pocket
- ▶ Large pocket is lined with two layers of 1000D Cordura
- ▶ Webbed belt adjusts to a 50 inch (127 cm) waist
- ▶ Includes a hammer loop and marker storage
- ▶ Weighs 1.05 lb (0.48 kg)



8046-30-ORG — Surveyor's Tool Pouch with Belt

## GNSS Pole and Tripod Bags

Designed to keep your GNSS tripods and rods safe and secure

- ▶ This bag features heavy-duty Cordura® and reinforced Rhinotek™ material
- ▶ Shoulder strap is included
- ▶ Use with Heavy-Duty GNSS Antenna Tripods (5119-10)
- ▶ Measures: 8 inch ID x 56 inches (20.32 x 142.24 cm)
- ▶ Weighs 1.80 lb (0.82 kg)



8154-12-ORG — Heavy-Duty GNSS Tripod Bag 

- ▶ Use with our Collapsible GNSS Antenna Tripod (5119-00) or other conventional tripods
- ▶ Designed to carry the tripod without the point on the center pole to prevent damage to the pole
- ▶ Features a full length heavy-duty zipper
- ▶ Weighs 1.70 lb (0.77 kg)
- ▶ Inside Dimensions: 7" x 50"



8154-00-ORG — Collapsible GNSS Antenna Tripod Bag 

- ▶ Designed to protect the rods during transportation or storage
- ▶ 5.5 ID x 41 inches long with a 10" flap
- ▶ Weighs 0.45 lb (0.20 kg)



8162-00-ORG — GPS Rover Rod Carrying Case 

- ▶ Replacement carrying case for Radio Antenna Tripod
- ▶ Case comes included when you purchased the Radio Antenna Tripod (5300-11 & 5300-12)
- ▶ Outside Dimensions: 8 inches x 54 inches



8154-10-ORG — Radio Antenna Tripod Carrying Case 

- ▶ Features a full-length zipper and shoulder strap
- ▶ Measures: 82 x 9 OD inches (208.28 x 22.86 OD cm)
- ▶ Weighs 1.88 lb (0.85 kg)



8153-10-ORG — Extra-Large Antenna Tripod Bag 

- ▶ This bag holds a 2 meter Snap-Lock pole and bipod or tripod (connected)
- ▶ Constructed of tough Cordura material and Rhinotek ends
- ▶ Measures 56 inches long (1.42 m)
- ▶ Weighs 1.50 lb (0.68 kg)



8151-02-FLY — Heavy-Duty Snap-Lock 2-Meter Pole System Bag 

## Instrument Tripod Bags and Cases

Designed to keep your instrument tripods safe and secure

- ▶ The SECO Instrument Tripod Bag holds all major brands of aluminum and wooden tripods
- ▶ Made of heavy-duty nylon Cordura, with a Rhinotek bottom, and pull string ties at the top
- ▶ Measures: 52 x 8.75 OD inches (132 x 22.23 OD cm)
- ▶ 8150-20 weighs 1.85 lb (0.84 kg)



8150-20-ORG — Heavy-Duty Tripod Bag with Rhinotek Bottom 

- ▶ Heavy-duty bag for carrying many different brands of tripods, including SECO and Tri-Max
- ▶ Features zipper closure
- ▶ Measures: 48 x 8 OD inches (121.9 x 20.3 OD cm)
- ▶ Weighs 1.80 lb (0.82 kg)



8154-11-ORG — Super-Duty Tripod Bag 



### Rover Rods and Prism Pole Tripod Cases

Designed to keep your Rover rod, Robotics pole and Prism pole tripods safe and clean

- ▶ Store your two-piece rover rod in this hard shell case and know it's protected
- ▶ Measures 4 ID x 41 in (10.16 ID x 104.14 cm)
- ▶ Weighs 3.20 lb (1.40 kg)



8162-20-BLK — GNSS Rover Rod Hard Shell Case

- ▶ External and internal side pockets hold extra gear
- ▶ Measurements: 6 OD x 58 inches (15.25 OD x 147.32 cm)
- ▶ Weighs 2.70 lb (1.23 kg)



8157-01-ORG — Long Padded System Bag

- ▶ Designed to carry a prism pole bipod or tripod attached (see page xx)
- ▶ Has a fold-over flap and shoulder strap
- ▶ Made from nylon Cordura and durable Rhinotek
- ▶ Measures: 7.5 ID x 60 inches (19.1 ID x 152 cm)
- ▶ Weighs 1.55 lb (0.70 kg)



8180-20-ORG — Heavy-Duty Prism Pole Bipod/Tripod Bag

- ▶ Protect your prism or range pole from dirt and moisture
- ▶ Measures: 61.5 x 6 in (156.21 x 15.24 cm)
- ▶ Weighs 0.68 lb (0.31 kg)



8160-00-ORG — Prism or Range Pole Protective Bag

- ▶ The heavy-duty material-covered tube holds one- or two-section poles or rods
- ▶ Measures: 65 inches (1.63 m) in length
- ▶ Use to protect and carry your pole or rod
- ▶ Weighs 5.50 lb (2.50 kg)



8160-20-BLK — Prism Pole Hard Shell Case

### Assorted Rod Carrying Cases

Designed to keep your One Shot, DE rod, Range pole, LR-STD, LR-PRO and CR rod safe and clean

- ▶ This carrying case is made from the highest quality 1000-denier nylon
- ▶ Water-resistant
- ▶ Measures: 4.5 x 82 inches (11.4 x 208.3 cm)
- ▶ Weighs 0.45 lb (0.20 kg)



91402 — LR-STD/LR-PRO Carrying Case

- ▶ Fits 13 ft (4 m), 16 ft (5 m) and 20 ft (6 m) rods
- ▶ Made from 1000-denier nylon
- ▶ Water-resistant
- ▶ Measures: 4.25 x 65.5 inches (10.8 x 166.4 cm)
- ▶ Weighs 0.45 lb (0.20 kg)



91411 — CR-13/16/20 ft / SVR-17/25 Carrying Case

- ▶ Textured heavy-duty poly
- ▶ Measures 7.5 x 46 inches (19.05 x 116.84 cm)
- ▶ Weighs 0.48 lb (0.22 kg)



8170-00-ORG — Range Pole Case

- ▶ Fits 8 ft (2.4 m) rods
- ▶ Made from 1000-denier nylon
- ▶ Water-resistant
- ▶ Measures: 3.5 x 56.5 inches (8.9 x 143.5 cm)
- ▶ Weighs 0.30 lb (0.14 kg)



91410 — CR-8 ft/2.4m Carrying Case

#### BACK BY POPULAR DEMAND!

This DE Rod Bag, previously discontinued, has been brought back through customer requests

- ▶ Extremely durable Cordura(R) bag with reinforced bottom
- ▶ Pocket for a sensor bracket
- ▶ Shoulder strap included
- ▶ 4 x 71 inch (10.16 x 180.34 cm)
- ▶ Weighs 0.5 lb (0.23 kg)



8166-01-ORG — Direct Elevation Rod Bag

### CMR Measuring Ruler Cases

- ▶ Made from the highest-quality 1000-denier nylon.
- ▶ For use with our rugged fiberglass CMR Series Measuring Rulers 90180, 90181 and 90182, and for gopher pole 90520 on page 53.

PART NO.	SIZE	
91415	3.5 x 65 in (8.89 x 165.1 cm)	
91416	4.5 x 68 in (11.43 x 172.72 cm)	
91417	4.5 x 76 in (11.43 x 193.04 cm)	



### Lath and Stake Bags

Designed to hold your lath and stakes secure

- ▶ Carries up to 50 lath or rebar
- ▶ Measures 9 x 38 inches (2.54 x 96.52 cm)
- ▶ Weighs 0.22 lb (0.10 kg)



8102-01-ORG — 38 inch Lath Carrier

- ▶ Carries up to 50 lath or rebar
- ▶ Measures 9 x 38 inches (2.54 x 96.52 cm)
- ▶ Weighs 0.22 lb (0.10 kg)



8102-00-ORG — 38 inch Lath Carrier

- ▶ Use to carry 21 inch (53 cm) or 30 inch (76 cm) flags
- ▶ 8093-00-ORG weighs 0.22 lb (0.10 kg)
- ▶ 8094-00-ORG weighs 0.28 lb (0.13 kg)



8093-00-ORG — Wire Stake Flag Bag for 21 in Flags   
8094-00-ORG — Wire Stake Flag Bag for 30 in Flags

- ▶ Holds 24 inch (61 cm) wood lath
- ▶ Features a hand loop, shoulder strap, outside pocket
- ▶ 8 inch (20.3 cm) inside diameter
- ▶ Weighs 0.40 lb (0.18 kg)



8103-20-ORG — Heavy-Duty Rhinotek Lath Bag

- ▶ Heavy-duty lath carrier fits 36 or 48-inch lath
- ▶ Features space inside for any standard 12 inch, five-gallon bucket
- ▶ Weighs 1.50 lb (0.68 kg) without bucket and approx. 3.85 lb (1.75 kg) with bucket added



8104-20-ORG — Heavy-Duty Bucket Lath Carrier

- ▶ The main compartment of this bag is constructed of tough Rhinotek™ material and designed to hold 18 inch stakes or rebar
- ▶ Include hammer loop, adjustable strap and brass grommet drain holes — the 8091-20-ORG features a partition
- ▶ Standard bag weighs 1.55 lb (0.70 kg)
- ▶ Partitioned bag weighs 1.70 lb (0.77 kg)



8090-20-ORG — Heavy-Duty 18-inch Bag for Stakes or Rebar   
8091-20-ORG — Heavy-Duty 18-inch Bag w/ Center Partition

- ▶ Heavy-Duty Lath Bag but with Rhinotek material on the bottom and six inches up the sides
- ▶ Designed in two sizes: 8 inches wide by 36 or 48 inches deep
- ▶ Both weigh approximately 1.50 lb (0.68 kg)



8100-20-ORG — 36 inch Heavy-Duty Lath or Rebar Bag   
8101-20-ORG — 48 inch Heavy-Duty Lath or Rebar Bag

- ▶ This stake bag is the same as the 8090-20-ORG, but holds 24 inch stakes
- ▶ Features a Rhinotek bottom
- ▶ Standard bag weighs 1.70 lb (0.77 kg)
- ▶ Partitions bag weighs 1.60 lb (0.73 kg)



8092-20-ORG — Heavy-Duty 24-inch Bag for Stakes or Rebar   
8096-20-ORG — Heavy-Duty 24-inch Bag w/ Center Partition

- ▶ Choose between a standard spray can holder or a holder with updated features like four pockets for pens/pencils and a heavy web strap
- ▶ Both weighs approximately 1.00 lb (0.45 kg)



8098-00-ORG — Standard Spray Can Holder   
8098-10-ORG — With Accessory Pockets (shown)

### Front and Top Loading Total Station Cases

Heavy-duty cases for your Total Station



#### FEATURES & BENEFITS

- ▶ Features a Rhinotek™ bottom and durable backpack straps

- ▶ Measures between the pads: 14 x 9 x 7 in (35.6 x 22.9 x 17.8 cm)

#### Applications

- ▶ Keeps your total station safe and secure during transport

PART NO.	LOADING SPACE	FEATURES	WEIGHS
8120-00-ORG	Front Loading	Cloth Frame	5.75 lb (2.61 kg)
8121-00-ORG	Top Loading	Cloth Frame	5.75 lb (2.61 kg)
8123-00-ORG	Top Loading	Aluminum Frame	7.50 lb (3.40 kg)



### Total Station, GIS and GNSS Backpacks

Designed to keep your Total Station, GIS and GNSS equipment safe and secure

- ▶ This pack includes a cam-lock antenna pole, adjustable straps, several interior pockets, belt loop straps, rain flap and much more
- ▶ Interior dimensions (measured between the pads): 15 x 9 x 4 in
- ▶ Pole extends from 15 7/8 to 32 inches (40.3 to 81.3 cm)
- ▶ Has 5/8 x 11 tip on antenna pole
- ▶ Weighs 2.00 lb (0.91 kg)



8125-50-ORG — Small GIS Backpack 

- ▶ The Total Station Backpack is similar in style to a commercially available lightweight day pack
- ▶ Main compartment has an innovative 'wrap' made of 3/8-inch high-density foam with hook and loop adjustment that securely cradles all total stations
- ▶ Features extra pockets and Rhinotek™ bottom
- ▶ 8120-40: Height – 18" (46 cm), Bottom – 9" X 10" (23 cm x 25 cm)
- ▶ 8120-30: Height – 15" (38 cm), Bottom – 7" X 9" (18 cm x 23 cm)
- ▶ Weighs 2.40 lb (1.10 kg)



- ▶ Features a double-zipped, top-loading station compartment lined with rigid foam padding, two side pockets for cables, and one front battery pocket
- ▶ Comfortable padded belt with lumbar back support system, shoulder straps with all-point adjustment features, and a rubberized carrying handle
- ▶ The free-standing aluminum frame keeps the pack upright even when fully loaded
- ▶ Has a top rain flap with closure and rain flaps on the side pockets
- ▶ Features a Rhinotek bottom
- ▶ Interior dimensions (measured between the pads): 17 x 10 x 10 in
- ▶ Exterior dimensions: 24.5 x 15 x 16 in
- ▶ Weighs 8.00 lb (3.62 kg)
- ▶ Holds 40 lb (18.14 kg)



8134-00-ORG — Robotics Backpack 

- ▶ 311FX — Level pattern Side-stapled Notebook for Tough Conditions 
- ▶ 301FX — Transit pattern Side-stapled Notebook for Tough Conditions 

- ▶ Overall Size: 4.625 x 7 inches (11.75 x 17.78 cm)
- ▶ Soft Cover Material: Polydura (recycled material)
- ▶ Binding: side-spiral
- ▶ Number of Pages: 64 (32 sheets)
- ▶ Weighs 0.20 lb (0.09 kg)



8125-11-ORG — Large GIS Backpack with Cam-Lock Antenna Pole 

### Prism and Tribrach Bags

Designed to keep prisms and tribrachs secure

- ▶ Heavily padded for single prisms
- ▶ Interior dimensions (measured between the pads): 5 x 7 x 2 inches
- ▶ Weighs 0.48 lb (0.22 kg)



8070-00-ORG — Single Prism Bag 

- ▶ For triple prisms and prism targets or tribrachs
- ▶ Interior dimensions (measured between the pads): 10 x 9.5 x 3 inches
- ▶ Weighs 1.06 lb (0.48 kg)



8081-00-ORG — Jumbo Triple Prism Bag 

- ▶ Heavily padded for triple prisms
- ▶ Interior dimensions (measured between the pads): 9 x 7 x 2 inches
- ▶ Weighs 0.75 lb (0.34 kg)

**Prism and Tribrach Bags make excellent tablet bags for the field!**



8080-00-ORG — Triple Prism Bag 

- ▶ Easily holds a tribrach
- ▶ Interior dimensions (measured between the pads): 6 x 6 x 2 inches
- ▶ Weighs 0.40 lb (0.18 kg)



8071-00-ORG — Tribrach Case 

- ▶ Holds a tilting prism with tribrach and adapter
- ▶ Interior dimensions (measured between the pads): 12 x 12 x 3 inches
- ▶ Weighs 1.85 lb (0.84 kg)



8082-00-ORG — Super Jumbo Padded Bag 

- ▶ Designed for vertical triple prism assemblies
- ▶ Holds target with tribrach and adapter
- ▶ Interior dimensions (measured between the pads): 15 x 8 x 2 inches
- ▶ Available in Orange
- ▶ Weighs 1.45 lb (0.66 kg)



8130-00-ORG — Tall Triple Prism Bag 

**ChrisNik MagNails®,  
MagSpikes® and MagHubs®**

Corrosion resistant and magnetized for easy detection

- ▶ Mag Nails have been coated with an environmentally friendly zinc and clear chromate to resist corrosion
- ▶ Stronger, more durable, higher quality, magnetic and longer lasting than other nails
- ▶ Mag Nails are larger and magnetic making them easier to locate using the naked eye or a locator
- ▶ Each box includes 100 Mag Nails

- ▶ Constructed of premium steel that produces the most durable survey marker in the industry
- ▶ Like the Mag Nail the Mag Spike is magnetized for easy detection
- ▶ Featuring a large center point and 1-inch (25.4 mm) diameter head makes it great for control points and property corners
- ▶ Made in the USA

- ▶ The Mag Hub is magnetized for easy detection and zinc plated to resist corrosion
- ▶ Featuring a large center point and looks like a standard survey marker
- ▶ Not made to be driven into asphalt or concrete
- ▶ Easy to carry and less expensive than stakes
- ▶ Mag Hubs come in a 30 lb (13.61 kg) box approximate quantities are below



PART NO.	SIZE	QUANTITY	WEIGHTS
<b>ChrisNik MagNails</b>			
24750-CS	3/4 x 1/8 inch	100 per box, 12 box per case	7 lb/case
241000-CS	1 x 5/32 inch	100 per box, 12 box per case	11 lb/case
241250-CS	1 1/4 x 3/16 inch	100 per box, 12 box per case	18 lb/case
241500-CS	1 1/2 x 1/4 inch	100 per box, 12 box per case	33 lb/case
242000-CS	2 x 1/4 inch	100 per box, 12 box per case	41 lb/case
242500-CS	2 1/2 x 1/4 inch	100 per box, 12 box per case	48 lb/case
<b>ChrisNik MagSpikes</b>			
253MAGSPIKE	3/8 x 3 inch	25 per box	2.5 lb (1.13 kg)
256MAGSPIKE	3/8 x 6 inch	20 per box	4.00 lb (1.18 kg)
258MAGSPIKE	3/8 x 8 inch	20 per box	5.00 lb (2.27 kg)
<b>ChrisNik MagHubs</b>			
23MAGHUB6	1/4 x 6 inch	Approx...367	30.00 lb (13.61 kg)
23MAGHUB8	1/4 x 8 inch	Approx...272	30.00 lb (13.61 kg)

**Flagging Dispenser  
and Marker**

- ▶ The steel Presco Roll Flagging Belt Dispenser is a convenient time-saver
- ▶ Weighs 1.30 lb (0.59 kg)



8025-00-ORG — Padded Flagging Dispenser

- ▶ Permanent marker are leak-proof with a seamless metal body
- ▶ Chisel tip marks are extremely durable on wood, metal, and more
- ▶ AP certified non-toxic
- ▶ Box of 12 weighs 3.75 lb (1.70 kg)



9060-14 — Dixon Redimark Marker - Black

### Miscellaneous Accessories

- ▶ Choose between a 17.5 inch blade and a 13 inch blade for clearing that thick underbrush on the job site
- ▶ Weighs approx. 1.00 lb (0.45 kg)



9500-17 — 17.5 inch blade, includes sheath  
 9500-13 — 13 inch blade, includes sheath

- ▶ 9500-01 for knife and scissor sharpening
- ▶ 9500-02 for Axes or other edged tool sharpening
- ▶ 9500-01 weighs 0.05 lb (0.02 kg)
- ▶ 9500-02 weighs 0.20 lb (0.09 kg)



9500-01 — For knives and scissors  
 9500-02 — For hand tools

- ▶ Shot bags are great for holding down maps or blueprints in windy conditions
- ▶ Weighs 1.50 lb (0.68 kg)



8010-10-BLU — Cordura Shot Bag

- ▶ Lightweight aluminum center punches are great for marking a variety of materials or punching starter holes for nails or drill bits
- ▶ Durable removable-tip scribes are perfect for making quick and accurate marks on hard work pieces
- ▶ The scriber features a durable tungsten carbide point that is able to make precise marks to 1/100th of an inch
- ▶ The magnetic cap quickly cleans up stray metal shavings



9068-02 — Heavy-Duty Center Punch  
 9068-03 — Carbide Scriber

- ▶ Replacement caps and points fit all SECO plumb bobs



6000-001 — Plumb Bob Cap  
 6000-002 — Plumb Bob Point

- ▶ Pin cushion for holding stake tacks



25456855 — Stake Tacks 1 LB  
 2180-00 — Regular Tac Ball  
 2180-01 — Tac Ball with Clip

- ▶ The 3/16 inch spring steel, 14 inch pins are powder-painted red and white, alternating at each inch
- ▶ Quiver (8041-00-ORG) sold separately
- ▶ Weighs 1.54 lb (0.70 kg)



2183-00 — Marking Pins 11 count

- ▶ 6001-06
- ▶ Gammon Reel® Plumb Line Reel for Surveyors
- ▶ Designed for use in the surveying field
- ▶ 6-1/2 foot (1.9m) orange string
- ▶ Quickly retracts eliminating tangled string
- ▶ 6001-12
- ▶ Gammon Reel® Plumb Line Reel
- ▶ Designed for use in the construction field
- ▶ 12 foot (3.6m) fluorescent red string
- ▶ Mylar® protected target also serves as a sight
- ▶ Quickly retracts eliminating tangled string



6001-06 — Gammon Reel 6.5 ft (1.9m)  
 6001-12 — Gammon Reel 12 ft (3.7 m)

- ▶ 24 yard (7.3m) bobbin of Gammon Reel refill cord
- ▶ Available in Flo Red and Orange



6001-FR — Gammon Reel Refill - Flo Red  
 6001-OR — Gammon Reel Refill - Orange

- ▶ Each solid brass bob features a hardened steel point and a storage area for a spare point



6000-012	12 oz	340 g	
6000-014	14 oz	397 g	
6000-016	16 oz	454 g	
6000-018	18 oz	510 g	
6000-024	24 oz	680 g	
6000-032	32 oz	907 g	

- ▶ Heavy-duty sheath is double stitched top grain leather with a belt loop for SECO plumb bobs



6000-120 — Leather Sheath for 10-12 oz (283-340 g)  
 6000-160 — Leather Sheath for 14-18 oz (397-454 g)  
 6000-240 — Leather Sheath for 24-32 oz (510-907 g)

- ▶ 10 lb of Shiners with bag included
- ▶ 2181-10 - approximate qty: 1,125
- ▶ 2182-10 - approximate qty: 1,300
- ▶ Weighs 10.00 lb (4.53 kg)



2181-10 — Bulk Shiners - Flat  
 2182-10 — Bulk Shiners - Raised

- ▶ Raised Shiners are 1.94 in (49.3 mm) OD
- ▶ Features a raised 29 mm center
- ▶ Weighs 1.00 lb (0.45 kg)



2182-00 — Raised Shiners, 260 count

- ▶ Flat shiners are 2.25 in (57.2 mm) OD
- ▶ Featuring punched centers with crimped edges
- ▶ Weighs 2.60 lb (1.18 kg)



2181-00 — Flat Shiners, 250 count



Rite in the Rain

- ▶ Rite in the Rain bound books ensure that your valuable data won't be lost
- ▶ These all-weather books have 160 pages (80 sheets), including a title and contents page
- ▶ This 4-3/4 x 7-1/2 inch yellow field book also features a sewn binding
- ▶ Weighs 0.65 lb (0.29 kg)



Transit Pattern  
8 vertical lines  
to the inch



Level Pattern  
6 vertical columns  
on the page



- 300F — Transit Pattern Bound Book
- 310F — Level Pattern Bound Book

- ▶ Overall Size: 4.625 x 7 inches (11.75 x 17.78 cm)
- ▶ Cover Material: field flex
- ▶ Binding: side stapled
- ▶ Number of Pages: 48 (numbered)
- ▶ Number of Sheets: 24
- ▶ Sold in Packs of 3
- ▶ Weighs 0.56 lb (0.25 kg) (3-pack)



- 311FX — Level pattern Side-stapled Notebook
- 301FX — Transit pattern Side-stapled Notebook

- ▶ Page Size: 4.625 x 7-inch (11.75 x 17.78 cm)
- ▶ Fits Yellow Binder (Part No. 200)
- ▶ Pattern: Field
- ▶ Sold in Packs of 100 sheets
- ▶ Weighs 0.55 lb (0.25 kg)



- 352 — Field pattern Standard Loose Leaf Sheets

- ▶ Overall Size: 4.625 x 7 inches (11.75 x 17.78 cm)
- ▶ Soft Cover Material: Polydura (recycled material)
- ▶ Binding: side-spiral
- ▶ Number of Pages: 64 (32 sheets)
- ▶ Weighs 0.20 lb (0.09 kg)



- 303 — Transit pattern Recyclable Side-spiral Notebook
- 353 — Field pattern Recyclable Side-spiral Notebook



PART NUMBER	PAGE	PART NUMBER	PAGE	PART NUMBER	PAGE	PART NUMBER	PAGE	PART NUMBER	PAGE
23MAGHUB6	73	2153-07-BLK	40	4811-24	56	5125-057-FLY	13	5194-10-002	24
23MAGHUB8	73	2153-10-BLK	41	4811-24P1	56	5125-058	25	5195-01	24
253MAGSPIKE	73	2154-02-BLK	40	4811-24P2	56	5125-06-YEL	10	5196-17	10
256MAGSPIKE	73	2154-04-BLK	40	4811-24P3	56	5125-20-FLY	11	5196-18	10
258MAGSPIKE	73	2154-BATT	40	4811-24P4	56	5125-20-YEL	11	5196-19	10
303	75	2159-01-BLK	38	4811-24P5	56	5125-22-FLY	11	5196-20	10
352	75	2159-04-BLK	38	4811-24P6	56	5126-10	13	5196-22	10
353	75	2159-050	38	4811-24P7	56	5128-00	10	5198-052	9
2001-00	41	2159-10	37	4811-24P8	56	5128-052	13	5198-054	9
2002-00	41	2159-11	37	4811-32	56	5128-08	10	5198-055	9
2010-00	41	2159-12	37	4811-32P1	56	5128-20	11	5198-056	9
2020-00	41	2159-13	37	4811-32P2	56	5128-22	11	5198-059	9
2070-00	41	2159-14	37	4811-32P3	56	5128-24	11	5198-073	9
2070-02	18	2159-15	37	4811-32P6	56	5129-50	11	5198-081	9
2071-00	41	2180-00	74	4852-14	57	5129-51	11	5198-086	9
2072-050	5	2180-01	74	4852-15	62	5129-52	19	5198-152	9
2072-30	5	2181-00	74	4852-16	62	5129-53	19	5198-153	9
2072-31	5	2181-10	74	4852-17	61	5129-54	19	5198-157	23
2072-32	5	2182-00	74	4852-18	62	5129-70	11	5198-163	23
2072-33	5	2182-10	74	4900-00	24	5129-71	11	5198-52	15
2072-51	61	2183-00	74	5001-10	16	5129-72	19	5199-050	8
2072-52	61	241000-CS	73	5001-12	16	5129-73	19	5199-051	8
2072-60	61	241250-CS	73	5001-20	16	5130-00-FLY	25	5199-052	8
2080-00	24	241500-CS	73	5010-00-FLY	20	5130-01-FLY	25	5199-054	8
2080-SS	24	242000-CS	73	5010-00-RED	20	5130-10	25	5200-050	8
2090-00	12	242500-CS	73	5010-01	20	5131-00-YEL	25	5200-058	8
2090-01	12	24750-CS	73	5070-051-40	16	5131-01-FLY	25	5200-059	8
2090-02	12	3003-06	52	5079-066	21	5132-00-ACL	25	5200-062	8
2090-04	12	3003-07	52	5081-052-40	16	5139-02-FLY	13	5200-064	8
2090-06	12	3003-08	52	5110-00-FLY	25	5140-02-WOR	25	5200-065	8
2090-07	12	3003-10	52	5110-00-RED	25	5143-00-FLY	25	5200-069	8
2090-10	21	3003-14	52	5110-01-FLY	25	5143-02	25	5200-070	8
2090-11	21	3006-06	52	5111-00	12	5144-00-FLY	25	5200-072	8
2090-12	21	3006-07	52	5111-00-SS	12	5144-02	25	5200-073	8
2090-13	21	3006-10	52	5111-04	13	5145-00-FLY	25	5200-074	8
2090-14	21	3006-11	52	5111-04-051	13	5145-02	25	5200-075	8
2090-15	21	3006-18	52	5113-012	13	5145-03	25	5200-076	8
2090-17	21	300F	75	5114-01	13	5150-02-WOR	25	5200-077	8
2090-19	21	301FX	75	5114-02	13	5160-02-WOR	25	5200-150	9
2090-21	21	310F	75	5114-050	13	5180-00	24	5200-151	9
2090-26	21	311FX	75	5114-051	13	5181-00	24	5200-152	9
2120-00	13	4 520 800	61	5114-10	13	5182-001	25	5200-154	9
2130-00	13	4040-05	54	5114-20-XXX	14	5187-00	12	5200-155	9
2131-00	24	4040-30	54	5114-21-XXX	14	5187-00-SS	12	5200-16-050	7
2131-01	24	4040-60	54	5114-40-01	15	5190-00	24	5200-160	9
2132-01	13	4050-01	54	5114-40-02	15	5191-00	24	5200-164	9
2133-03	10	4200-00	54	5115-00-FLY	5	5192-00	24	5200-165	9
2133-05	10	4300-00	54	5115-00-YEL	5	5192-02	24	5200-166	9
2133-06	13	4769-00	52	5119-00-FLY	5	5193-04	24	5200-17-050	7
2152-04-BLK	41	4769-01	52	5119-00-FOR	5	5194-00	24	5200-201	8
2152-05-BLK	41	4769-02	52	5119-00-YEL	5	5194-003	24	5200-29-050	7
2152-06-BLK	40	4769-03	52	5119-10-FLY	5	5194-007	24	5200-30	7
2152-07-BLK	40	4769-04	52	5119-10-YEL	5	5194-01	24	5200-31	7
2153-02-BLK	41	4769-06	52	5125-00-YEL	10	5194-03	24	5200-32	7
2153-04-BLK	41	4769-14	52	5125-01-YEL	10	5194-04	24	5200-33	7
2153-05-BLK	41	4770-00	52	5125-050	13	5194-05	24	5200-35	7
2153-06-BLK	40	4770-01	52	5125-056	13	5194-10	24	5200-39-052	6



PART NUMBER	PAGE	PART NUMBER	PAGE	PART NUMBER	PAGE	PART NUMBER	PAGE	PART NUMBER	PAGE
5200-42	7	5500-064-40	16	5910-02-ARD	34	6411-00	37	7301-40	49
5200-43	7	5500-11	21	5910-05	34	6411-02-BLK	37	7301-50	49
5200-95	6	5500-21	21	5910-06	34	6411-03-BLK	37	7304-01	48
5200-96	6	5500-23	20	5910-24	34	6411-04-BLK	37	7321-050	48
5214-00	27	5500-30	21	6000-001	74	6416-00	37	7321-30	49
5214-01	25	5501-11	20	6000-002	74	6422-02-FOB	29	7321-40	49
5216-00	33	5503-30	20	6000-012	74	6422-02-YLB	29	7321-50	49
5217-04-FLY	26	5512-11	21	6000-014	74	6422-20-YLB	29	7341-40	49
5217-04-FOR	26	5512-13-FLY-GM	12	6000-016	74	6440-00-FOR	31	7341-41	49
5217-04-RED	26	5512-14-FOR-GT	12	6000-018	74	6450-00-BLK	34	7341-45	49
5217-04-YEL	26	5520-11	21	6000-024	74	6455-00	32	7341-51	49
5217-05-FLY	27	5520-21	21	6000-032	74	6600-01	36	7341-52	49
5217-05-FOR	27	5520-30	21	6000-120	74	6600-02	36	7341-55	49
5217-05-RED	27	5521-11	20	6000-160	74	6600-03	36	7341-56	49
5217-05-YEL	27	5527-10	11	6000-240	74	6600-04	36	8010-10-BLU	74
5217-072	26	5527-11	11	6001-06	74	6600-05	36	8025-00-ORG	73
5217-15-ABK	12	5527-13	11	6001-12	74	6600-10	34	8030-00-CABLU	54
5217-20-FLY	48	5527-15	11	6001-FR	74	6601-01	36	8046-10-BLU	15
5217-21-FOR	48	5527-16	11	6001-OR	74	6601-01	48	8046-20-ORG	68
5217-30	27	5527-17	11	6020-01	37	6601-02	36	8046-30-ORG	68
5217-40-FLY	26	5527-20	11	6020-02	37	6601-03	36	8063-42-FLY	66
5217-40-RED	26	5527-22	11	6200-10-FOR	33	6601-04	36	8063-46-FLY	66
5217-40-YEL	26	5527-30	11	6200-11-FOR	33	6602-01	60	8063-46-FOR	66
5218-02-FLY	27	5530-10	23	6341-00	32	6602-02	60	8063-50-FLY	66
5218-02-FOR	27	5530-20	23	6341-11	32	6602-03	60	8063-50-FOR	66
5218-02-RED	27	5530-30	23	6400-00	32	6603-00	35	8063-54-FLY	66
5218-02-YEL	27	5531-10	23	6400-10	32	6603-00-005-TMB	35	8063-54-FOR	66
5218-06-FLY	26	5531-20	23	6401-00-YEL	12	6603-00-050	35	8063-58-FLY	66
5218-06-FOR	26	5531-30	23	6402-02-FLB	29	6603-01	35	8063-58-FOR	66
5218-06-RED	26	5540-10	22	6402-02-FOB	29	6603-01-051	35	8063-62-FLY	66
5218-06-YEL	26	5540-20	22	6402-02-YLB	29	6603-03	36	8063-62-FOR	66
5218-15-ABK	27	5540-30	22	6402-03-FLB	29	6603-05	36	8063-66-FLY	66
5218-40-FLY	27	5541-10	22	6402-03-FOB	29	6603-06	36	8063-66-FOR	66
5218-40-RED	27	5541-20	22	6402-03-YLB	29	6703-001	17	8068-42-FLY	65
5218-40-YEL	27	5541-30	22	6402-05-FOB	30	6703-002	18	8068-42-FOR	65
5219-03	26	5561-20	6	6402-05-YLB	30	6703-005	18	8068-46-FLY	65
5219-05	26	5600-10	22	6402-06-FLB	30	6703-007	18	8068-46-FOR	65
5220-13-BLK	45	5610-00	47	6402-06-FOB	30	6703-008	18	8068-50-FLY	65
5220-13-ORG	45	5610-01	47	6402-06-YLB	30	6703-011	17	8068-50-FOR	65
5300-11	6	5610-11	47	6402-10-FLB	30	6703-012	18	8068-54-FLY	65
5300-12	6	5610-12	47	6402-10-FOB	30	6703-013	18	8068-54-FOR	65
5301-21-BLK	46	5610-15	46	6402-10-YLB	30	6703-014	18	8068-58-FLY	65
5301-21-ORG	46	5631-10	23	6402-20-FLB	29	6703-015	17	8068-58-FOR	65
5301-24-BLK	46	5631-20	23	6402-20-FOB	29	6703-10	18	8068-62-FLY	65
5301-25-BLK	46	5631-30	23	6402-20-YLB	29	6703-11	18	8068-62-FOR	65
5301-31-BLK	45	5700-10	21	6405-01-FLY	33	6703-20	18	8068-66-FLY	65
5301-31-ORG	45	5700-20	21	6405-01-FOR	33	6704-001	17	8068-66-FOR	65
5302-13-BLK	44	5700-21	20	6405-10-FOR	33	6704-002	17	8069-42-FLY	66
5302-13-ORG	44	5720-10	21	6405-11-FLY	33	6704-003	17	8069-42-FOR	66
5311-21-ORG	46	5801-052-40	16	6405-11-FOR	33	6704-004	17	8069-46-FLY	66
5321-16-BLK	45	5801-10	22	6405-12-FOR	33	6704-10	17	8069-46-FOR	66
5321-17-ORG	44	5802-10	20	6405-13-FLY	33	6704-10-CASE	17	8069-50-FLY	66
5401-21-BLK	46	5802-20	20	6406-00	31	6705-10	18	8069-50-FOR	66
5402-13-BLK	44	5813-10	22	6406-01	35	6705-20	19	8069-54-FLY	66
5402-13-ORG	44	5901-00-FLY	25	6406-02	35	70014-6	48	8069-54-FOR	66
5420-13-BLK	45	5902-00-FLY	25	6410-00	32	70014-7	48	8069-58-FLY	66
5420-13-ORG	45	5910-01-ARD	34	6410-018	32	7301-30	49	8069-58-FOR	66

PART NUMBER	PAGE	PART NUMBER	PAGE	PART NUMBER	PAGE	PART NUMBER	PAGE	PART NUMBER	PAGE
8069-62-FLY	66	8260-46-FOR	64	8365-66-FLY	63	92041	51	ATI991320-02	59
8069-62-FOR	66	8260-50-FLY	64	8365-66-FOR	63	92042	51	ATI991320-09	59
8069-66-FLY	66	8260-50-FOR	64	9060-14	73	92043	51	ATI991326-02	59
8069-66-FOR	66	8260-54-FLY	64	9068-02	74	92046	51	ATI991326-09	59
8070-00-ORG	72	8260-54-FOR	64	9068-03	74	92047	51	ATI991340-02	59
8071-00-ORG	72	8260-58-FLY	64	9500-01	74	92048	51	ATI991340-09	59
8080-00-ORG	72	8260-58-FOR	64	9500-02	74	98010	50	ATI991346-02	59
8081-00-ORG	72	8260-62-FLY	64	9500-13	74	98011	50	ATI991346-09	59
8082-00-ORG	72	8260-62-FOR	64	9500-17	74	98012	50	ATI991360-02	60
8082-01-ORG	18	8260-66-FLY	64	90004	50	98013	50	ATI991364-02	60
8090-20-ORG	71	8260-66-FOR	64	90009	50	98014	50	ATI991370-02	59
8091-20-ORG	71	8261-J-FLY	64	90014	50	98015	50	ATI991370-09	59
8092-20-ORG	71	8261-J-FOR	64	90022	50	98016	50	ATI991376-02	59
8093-00-ORG	71	8261-L-FLY	64	90024	50	98017	50	ATI991376-09	59
8094-00-ORG	71	8261-L-FOR	64	90026	50	98020	50	ATI991604	60
8095-20-ORG	68	8261-M-FLY	64	90180	53	98021	50	ATI993600-02	58
8096-20-ORG	71	8261-M-FOR	64	90181	53	98023	50	ATI993600-09	58
8098-00-ORG	71	8261-XL-FLY	64	90182	53	98024	50	ATI993640-09	58
8098-10-ORG	71	8261-XL-FOR	64	90520	53	98025	50	ATI994000-02	58
8100-20-ORG	71	8261-XXL-FLY	64	90550-S	43	98026	50	ATI994000-09	58
8101-20-ORG	71	8261-XXL-FOR	64	90550	42	99000	55	D11145	24
8102-00-ORG	71	8261-XXXL-FLY	64	90551	42	99001	55	D12560	17
8102-01-ORG	71	8261-XXXL-FOR	64	90553	42	99002	55	DE-50	57
8103-20-ORG	71	8265-42-FLY	63	90557-050	43	99003	55	DET-2	57
8104-20-ORG	71	8265-42-FOR	63	90558	43	99004	55	FPT144-BLK	39
8106-10-ORG	68	8265-46-FLY	63	90558-050	43	99023	55	FPT146-BLK	39
8106-20-ORG	68	8265-46-FOR	63	90558-052	43	99043	55	FPT247-BLK	39
8120-00-ORG	71	8265-50-FLY	63	90560	42	99051	55	GEOPRISM	31
8120-30-ORG	72	8265-50-FOR	63	90582	44	99052	55	ML-1	51
8120-40-ORG	72	8265-54-FLY	63	90653	42	99053	55	ML-1-050	51
8121-00-ORG	71	8265-54-FOR	63	91014	48	99060	54	ML-1M	51
8123-00-ORG	71	8265-58-FLY	63	91100	49	99061	54	RT481W-BLK	39
8125-11-ORG	72	8265-58-FOR	63	91133	48	99062	54	RT481WON-BLK	39
8125-50-ORG	72	8265-62-FLY	63	91162	49	99063	54	RT482W-BLK	39
8125-60-FOR	67	8265-62-FOR	63	91163	49	99064	54	RT482WON-BLK	39
8130-00-ORG	72	8265-66-FLY	63	91255	48	99065	54	RT484W-BLK	39
8134-00-ORG	72	8265-66-FOR	63	91258	48	99066	54	RT484WON-BLK	39
8142-01-ORG	68	8290-50-FLY	65	91275	48	99067	54		
8143-21-YEL	68	8290-50-FOR	65	91402	70	99068	54		
8143-22-FLY	68	8290-54-FLY	65	91410	70	99069	54		
8143-40-FLY	68	8290-54-FOR	65	91411	70	99070	54		
8150-20-ORG	69	8290-58-FLY	65	91415	53	99071	55		
8151-02-FLY	69	8290-58-FOR	65	91415	70	99072	55		
8153-10-ORG	69	8290-62-FLY	65	91416	70	99079	55		
8154-00-ORG	69	8290-62-FOR	65	91417	70	99080	55		
8154-10-ORG	69	8365-42-FLY	63	91535	48	99081	55		
8154-11-ORG	69	8365-42-FOR	63	91601	24	25456855	74		
8154-12-ORG	69	8365-46-FLY	63	91605	24	A452	39		
8157-01-ORG	70	8365-46-FOR	63	91641	24	A455	39		
8160-00-ORG	70	8365-50-FLY	63	92001	51	A456	39		
8160-20-BLK	70	8365-50-FOR	63	92002	51	A458	39		
8162-00-ORG	69	8365-54-FLY	63	92021	51	AL24A	56		
8162-20-BLK	70	8365-54-FOR	63	92022	51	AL24M	56		
8166-01-ORG	70	8365-58-FLY	63	92026	51	AL24M-2	56		
8170-00-ORG	70	8365-58-FOR	63	92027	51	AL32A	56		
8180-20-ORG	70	8365-62-FLY	63	92031	51	ATI010972-50	60		
8260-46-FLY	64	8365-62-FOR	63	92032	51	ATI010983	60		

PRODUCT CATEGORY/DESC	PAGE	PRODUCT CATEGORY/DESC	PAGE	PRODUCT CATEGORY/DESC	PAGE	PRODUCT CATEGORY/DESC	PAGE
<b>SECTION ONE</b>						<b>SECTION TWO</b>	
<b>GNSS Accessories</b>		Tripod Hook Brackets Designed for Nomad	10	GNSS Quick-Disconnect Adapter	12	<b>Laser Scanner Accessories</b>	
GNSS/MC Tripods: Quick Clamp	5	Tripod Hook Brackets Designed for TSC3 or Ranger 3	10	GNSS Quick-Disconnect Adapter (Stainless Steel)	12	100 mm Scanner Sphere	17
GNSS/MC Tripods: Screw Clamp	5	Tripod Hook Brackets Designed for Mesa Tesla	10	GNSS 60 mm Anti-Rotation Quick Release Adapter	13	230 mm Scanner Sphere	17
GNSS/MC Tripods: Quick Clamp/Screw Clamp	5	Tripod Hook Brackets Designed for Archer 2	10	GNSS Male 5/8 Adapter	13	Magnet with 5/8 x 11 Stud for Scanner Sphere	17
Network Adapter fits MPT 1-1/2 x 11-1/2 TPI	5	Two-Piece GNSS Rover Rod Aluminum	10	6 Foot Snap-Lock Radio Antenna Pole	13	21 mm Male and Female 5/8 x 11 Adapter for Scanner Sphere	17
Network Adapter fits MPT 2 x 11-1/2 TPI	5	Two-Piece GNSS Rover Rod Carbon Fiber	10	GNSS Quick-Release Triple Mag Mount	13	48 mm Male and Female 5/8 x 11 Adapter for Scanner Sphere	17
Network Adapter fits MPT 3-1/2 x 8 TPI	5	Telescopic Carbon Fiber Rover Rod Dual (10ths/2 mm)	11	GNSS 5/8 x 11 Triple Mag Mount	13	Carrying Case solo for Scanner Sphere	17
Network Adapter fits MPT 5/8 x 11 TPI	5	Telescopic Carbon Fiber Rover Rod Metric/2 mm	11	GNSS Triple Mag Mount for Trimble R10	13	Cloth cover for the 230 mm for Scanner Sphere	17
Network Adapter 40-minute leveling vial	5	Telescopic Carbon Fiber Rover Rod Dual (0.05 ft/cm)	11	GNSS 5/8 x 11 Tip	13	Hard Case and three (3) 230 mm Scanner Spheres	17
Radio Antenna Tripod Mast Assembly	6	Telescopic Carbon Fiber Rover Rod Dual (0.05 ft/cm)	11	GNSS Quick-Release Tip	13	196 mm HT Tribrach Adapter for TX5/FARO3D for Scanner Sphere	17
Radio Antenna Tripod Hardwood/Fiberglass	6	Snap-Lock Rover Rod Aluminum	11	GNSS Tripod Radio Antenna Kit	13	Quick Release Adapter for Trimble TX5 and Faro Focus 3D for Scanner Sphere	17
Radio Antenna Tripod Aluminum	6	Snap-Lock Rover Rod Carbon Fiber	11	GNSS Quick-Release Tip	13	100 mm Scanner Sphere with Magnet	18
Hands Free One Shoulder Tablet Harness	6	Quick Change Prism Pole Aluminum	11	GNSS Tripod Adapter 3-1/2 x 8 to 5/8 x 11	13	5/8 x 11, 72.5 mm HT Adapter	18
Hands Free Two Shoulder Tablet Harness	6	Quick Change Prism Pole Carbon Fiber	11	GNSS Tripod Adapter 5/8 x 11 to 3-1/2 x 8	13	72.5 HT Prism Assembly with Magnet	18
Quick Release Bracket Adapter for Hands Free Tablet Harness	6	Aluminum Pole Series with Locking Pins, Adapter GNSS Model	12	GNSS Tripod Adapter 5/8 x 11F to 1/4 x 20M	13	Scanner Sphere Mini Tripod	18
Pole Clamp: Ball and Socket Tablet	7	Aluminum Pole Series with Locking Pins, Adapter Robotic Model	12	<b>Vehicle Accessories</b>		6 piece 100 mm Sphere Kit includes Soft Case	18
Cradles: Claw Ball and Socket	7	Aluminum Pole Series with Locking Pins, Adapter Wild Prism Pole Adapter	12	GNSS Bracket for Truck	14	3/8 x 16 Tribrach Adapter	18
Pole Clamp: Tablet Quick Release	7	Accessories for Robotics Gear For Topcon Users w/ 77 mm Prism	12	GNSS Bracket for Truck Ford F-150 2015 & 2016 models	14	Wall Washer Adapter	18
Quick Release Claw Cradles	8	Accessories for Robotics Gear For Leica Users w/86 mm Prism	12	UTV Tubular Roll Cage Transporter for GNSS Rods	15	Magnet with 1/4 x 20 Stud	18
Quick Release Claw Cradles	8	Accessories for Robotics Gear Users w/115 mm Prism	12	UTV Rectangular Roll Cage Transporter for GNSS Rods	15	V-Base with Washer Magnet	18
Ball and Socket Suction Cup	8	Accessories for Robotics Gear Convert Robotics to GNSS Pole	12	Bracket ATV, TSC7 / Ranger 7	15	10 piece 100 mm Sphere Kit includes Hard Case	18
Ball and Socket Tripod Mount	8	Accessories for Robotics Gear For Topcon ATP1/2 with 50 mm Prism	12	Vehicle Plan Holder	15	Soft Case for 100 mm Scanner Spheres	18
Ball-and-Socket Link	8	Accessories for Robotics Gear 12 inch Open Clamp Bipod	12	<b>Vials and Levels</b>		Pelican Case for 100 mm Spheres	18
ATV Ball Clamp	8	360° Robotic Prism Assembly	12	Vial for TLV™ Locks	16	Scanner Target, Tilting, 6 B/W	18
Ram Ball Clamp Mount	8	GNSS Quick-Release Adapter	12	Vial for QLV™ Locks	16	Scanner Target, Adhesive, 150X200mm, B/W, 10pk	19
Quick Release Open-Style Clamps (for 1.25-inch OD pole)	9	GNSS Quick-Release Adapter (Stainless Steel)	12	Vial for 1.25-inch OD Pole Levels	16	<b>Specialty Prism Poles</b>	
Ball-and-Socket Clamps (for 1.25-inch OD pole)	9			Vial for 1.50-inch OD Pole Levels	16	Carbon Fiber Robotics Poles	19
Claw Quick Release Clamps (for 1.25-inch OD pole)	9			Heads-Up™ Level	16	Adjustable Tip Carbon Fiber Pole	19
Quick Release Cradle	9			Standard Rod Level	16	Mini Poles	20
Quick Release Cradle for Leica Pole Bracket	9			Snap-On Rod Level	16	Swiss-Style QLV Prism Pole	20
Tripod Data Collector Antenna Brackets	10						
Tripod Data Collector Radio Antenna Bracket	10						
Tripod Data Collector Hook TSC7 / Ranger 7	10						



PRODUCT CATEGORY/NUMBER	PAGE	PRODUCT CATEGORY/NUMBER	PAGE	PRODUCT CATEGORY/NUMBER	PAGE	PRODUCT CATEGORY/NUMBER	PAGE
GeoDesy Replaceable, Rechargeable Battery Pack	40	Tripod Stabilizer	47	Rhino Ruler Waterproof Fiberglass Engineer's Folding Ruler - 10ths / 8ths	52	<b>SECTION SEVEN</b>	
GeoDesy High-Precision Tribraich with Optical Plummet	40	Tripod Anchor Kit	47	Rhino Ruler Waterproof Fiberglass Engineer's Folding Ruler - 10ths / Metric	52	<b>Bullseye Construction Accessories</b>	
GeoDesy High-Precision Non-Optical Plummet Tribraich	40	<b>SECTION FIVE</b>		CMR Series Measuring Ruler	53	Bullseye Magnetic Mount For Backhoe and Excavator	60
GeoDesy Standard Precision Tribraich with Optical Plummet	40	<b>Leveling Rods, Accessories and Brackets</b>		Gopher Pole Wire Installation Tool	53	Bullseye Magnetic Mount For Flat Back Dozer Blades	60
GeoDesy Standard Precision Non-Optical Plummet Tribraich	40	Leveling Rod Vial	48	Gopher Pole Carrying Case	53	Bullseye Receiver cable, straight, 50 ft	60
<b>Tribraichs and Adapters</b>		Round 17 mm Button	48	<b>Stream Gauges and Supplies</b>			
Laser Tribraich	41	Round 13 mm Button w/ Ring	48	Stream Gauges Plate Numbers	54	Bullseye Machine power cable, lighter adapter, 2-8 ft	60
Rotating Tribraich Adapter	41	6-inch Caliper for SVR/Oval Rods and CMR Ruler	48	Hand Level 5 to 7 inch, 1X External Vial	54	Bullseye Universal battery charger with wall plugs	60
Tribraich with Optical Plummet	41	5/8 x 11 Double Male Prism Adapter	48	Hand Level 5 inch, 1X External Vial	54	Rebar Bolt 3/8 x 16 Threads	60
Tribraich w/o Optical Plummet	41	USL/SVR Hook	48	Hand Level 5 to 7 inch, 2X External Vial	54	Rebar Bolt M12 Threads	60
Prism H.T. Adapter	41	Swiss-Style Prism Adapter 1/4 x 20 Threads	48	Hand Level 6 to 7 inch, 2X Internal Vial	54	Rebar Bolt M8 Threads	60
Rotating Tribraich Adjuster	41	Snap-Tite SVR Rod Level	48	Hand Level 5 to 7 inch, 2X External Vial	54	<b>Monitoring Accessories, Wall/Column Clamps and Brackets</b>	
Fixed Tribraich Adapter	41	Snap-Tite CR Rod Level	48	Abney Hand Level	54	12.5 mm Street-Mountable Building Monitoring Prism System	61
Tribraich Adjuster	41	Leveling Plate	48	Hand Level Case	54	Screw Mounting Column Plate	61
Tribraich Adjusting Cylinder	41	5/8 x 11 Prism Mounting Adapter Kit	48	Stream Gauge	55	Column Plate	61
European-Style Tribraich with Optical Plummet	41	Leveling Rod Thumb Release Bipod	48	Mounting Hardware for Stream Gauge	55	Wall/Column Bracket for Lasers and Total Stations	61
European-Style Tribraich Non-Optical Plummet Tribraich	41	Invar Rod Thumb Release Bipod	48	<b>SECTION SIX</b>			
Traverse Tribraich Adapter	41	SVR Brackets for Laser Receivers	49	<b>Optical Instruments</b>		Wall Mount Bracket	61
<b>Tri-Max Tripods</b>		'E' Pattern Builder's Rods	49	Magnetic Dampened Auto Level	56	Heavy Duty Instrument Column Clamp	62
Fiberglass Tri-Max® Tripod	42	Aluminum Builder's Rods	49	Construction Theodolite	57	Heavy-Duty Column Clamp	62
Universal Tri-Max Elevator Tripod	43	Surveyor's Series (SVR) Leveling Rod	50	Construction Theodolite Diagonal Eye Piece	57	Column Clamp	62
1 Meter Extension for Universal Tri-Max Elevator Tripod	43	Standard/Pro Series (LR) Leveling Rod	50	Batter Board Clamp	57	<b>ANSI/ISEA Class Safety Utility Vests</b>	
Tri-Max Wheel Kit	43	Rectangular Series (CR) Leveling Rods	51	<b>Laser Detectors and Receivers</b>			
Adaptor Plate, 3/8-16	43	<b>Magnetic Locators</b>		Storm Laserometer Receiver - Red	58	Safety Utility Vest 8365-Series	63
Short Tri-Max	43	SubSurface Handheld Magnetic Locators Standard Model	51	Storm Laserometer Receiver - Yellow	58	Safety Utility Vest 8265-Series	63
<b>Instrument Tripod and Accessories</b>		SubSurface Handheld Magnetic Locators With LCD Meter	51	Lightning 2 Laser Detector - Red	58	Dual Safety Utility Vest 8260-Series U.S./Canada	64
Premier Fiberglass Tripod	44	Hard Shell Case for Locators	51	Lightning 2 Laser Detector - Yellow	58	Safety Utility Vest 8261-Series	64
Extra-Tall Fiberglass Elevator Tripod	44	<b>Measuring Tapes, Rulers, Cases and Gopher Pole</b>		Twister Laser Receiver - Yellow	58	Economy Safety Vest 8290-Series	65
Birch Wood / Fiberglass Hybrid Tripod	44	Heavy-Duty Pocket Tape	52	Bullseye 6 Laser Receiver	59	Safety Utility Vest 8068-Series	65
Heavy-Duty Birch Wood Tripods	45	Coated Fiberglass and Steel Measuring Tape	52	Bullseye 5+ Laser Receiver	59	Surveyors Utility Vest 8063-Series	66
Aluminum Elevator Tripod	45	<b>SECTION SEVEN</b>					
Square Leg Aluminum Tripod	45	<b>Bullseye Construction Accessories</b>					
Round Leg Aluminum Tripod	46	Bullseye Magnetic Mount For Backhoe and Excavator					
Tripod Dolly	46	Bullseye Magnetic Mount For Flat Back Dozer Blades					
		Bullseye Receiver cable, straight, 50 ft					
		Bullseye Machine power cable, lighter adapter, 2-8 ft					
		Bullseye Universal battery charger with wall plugs					
		Rebar Bolt 3/8 x 16 Threads					
		Rebar Bolt M12 Threads					
		Rebar Bolt M8 Threads					
		<b>Monitoring Accessories, Wall/Column Clamps and Brackets</b>					
		12.5 mm Street-Mountable Building Monitoring Prism System					
		Screw Mounting Column Plate					
		Column Plate					
		Wall/Column Bracket for Lasers and Total Stations					
		Wall Mount Bracket					
		Heavy Duty Instrument Column Clamp					
		Heavy-Duty Column Clamp					
		Column Clamp					
		<b>ANSI/ISEA Class Safety Utility Vests</b>					
		Safety Utility Vest 8365-Series					
		Safety Utility Vest 8265-Series					
		Dual Safety Utility Vest 8260-Series U.S./Canada					
		Safety Utility Vest 8261-Series					
		Economy Safety Vest 8290-Series					
		Safety Utility Vest 8068-Series					
		Surveyors Utility Vest 8063-Series					
		Safety Utility Vest 8069-Series					
		<b>Hydration Backpack, Bags and Cases</b>					
		Hydration Backpack					
		Monster Gear Bag					



PRODUCT CATEGORY/NUMBER	PAGE	PRODUCT CATEGORY/NUMBER	PAGE	PRODUCT CATEGORY/NUMBER	PAGE	PRODUCT CATEGORY/NUMBER	PAGE
Surveyor's Gear Bag with Rhinotek Bottom	68	Range Pole Case	70	Tribrach Case	72	Leather Sheath for 24-32 oz (510-907 g)	74
Large Controllers Case	68	Direct Elevation Rod Bag	70	Super Jumbo Padded Bag	72	Cordura Shot Bag	74
Heavy-Duty Collapsible Bucket Bag	68	CMR Series Measuring Ruler Case	70	Tall Triple Prism Bag	72	Heavy-Duty Center Punch	74
Trimble Pathfinder Series Pole Case	68	38 inch Lath Carrier	71	<b>Magnetic Nails</b>		Carbide Scriber	74
GNSS Rod Cell Phone Case	68	Wire Stake Flag Bag for 21 in Flags	71	Chrisnik MagNails	73	Gammon Reel 6.5 ft (1.9m)	74
MiFi Hotspot Case	68	Wire Stake Flag Bag for 30 in Flags	71	Chrisnik MagSpikes	73	Gammon Reel 12 ft (3.7 m)	74
Construction-Style Tool Pouch	68	Heavy-Duty Rhinotek Lath Bag	71	Chrisnik MagHubs	73	Gammon Reel Refill - Flo Red	74
Surveyor's Tool Pouch with Belt	68	Heavy-Duty Bucket Lath Carrier	71			Gammon Reel Refill - Orange	74
Heavy-Duty GNSS Tripod Bag	69	Heavy-Duty 18-inch Bag for Stakes or Rebar	71	<b>SECTION EIGHT</b>		Bulk Shiners - Flat	74
Radio Antenna Tripod Carrying Case	69	Heavy-Duty 18-inch Bag w/ Center Partition	71	<b>Flagging Dispenser and Marker</b>		Bulk Shiners - Raised	74
Collapsible GNSS Antenna Tripod Bag	69	36 inch Heavy-Duty Lath or Rebar Bag	71	Padded Flagging Dispenser	73	Raised Shiners, 260 count	74
Extra-Large Antenna Tripod Bag	69	48 inch Heavy-Duty Lath or Rebar Bag	71	Dixon Redimark Marker - Black	73	Flat Shiners, 250 count	74
GPS Rover Rod Carrying Case	69	Heavy-Duty 24-inch Bag for Stakes or Rebar	71	<b>Miscellaneous Field Accessories</b>		<b>Rite in the Rain</b>	
Heavy-Duty Snap-Lock 2-Meter Pole System Bag	69	Heavy-Duty 24-inch Bag w/ Center Partition	71	17.5 inch blade, includes sheath	74	Transit Pattern Bound Books	75
Heavy-Duty Tripod Bag with Rhinotek Bottom	69	Standard Spray Can Holder	71	13 inch blade, includes sheath	74	Level Pattern Bound Books	75
Super-Duty Tripod Bag	69	Standard Spray Can Holder With Accessory Pockets	71	Plumb Bob Cap	74	Level pattern Side-stapled Notebook for Tough Conditions	75
GNSS Rover Rod Hard Shell Case	70	Total Station Case	71	Plumb Bob Point	74	Transit pattern Side-stapled Notebook for Tough Conditions	75
Heavy-Duty Prism Pole Bipod/Tripod Bag	70	Small GIS Backpack	72	Solid Brass Bob	74	Field pattern Standard Loose Leaf Sheets	75
Long Padded System Bag	70	Total Station Backpack	72	Sharpener For Knives and Scissors	74	Transit pattern Recyclable Side-spiral Notebook	75
Prism or Range Pole Protective Bag	70	Robotics Backpack	72	Sharpener For Hand Tools	74	Field pattern Recyclable Side-spiral Notebook	75
Prism Pole Hard Shell Case	70	Large GIS Backpack with Cam-Lock Antenna Pole	72	Stake Tacks 1 LB	74		
LR-STD/LR-PRO Carrying Case	70	Single Prism Bag	72	Regular Tac Ball	74		
CR-8 ft/2.4m Carrying Case	70	Jumbo Triple Prism Bag	72	Tac Ball with Clip	74		
CR-13/16/20 ft / SVR-17/25 Carrying Case	70	Triple Prism Bag	72	Marking Pins 11 count	74		
				Leather Sheath for 10-12 oz (283-340 g)	74		
				Leather Sheath for 14-18 oz (397-454 g)	74		







[surveying.com](https://www.surveying.com)